



सिद्धिमूलं प्रबन्धनम्
भा. प्र. सं. इन्दौर
IIM INDORE

भारतीय प्रबंध संस्थान इंदौर

INDIAN INSTITUTE OF MANAGEMENT INDORE

प्रबंध शिखर, राउ पीथमपुर रोड, इंदौर - 453556 (म. प्र.) भारत

Prabandh Shikhar, Rau-Pithampur Road, Indore - 453556 (M.P.), India

Ph. 0731-2439620, Email: projectdept@iimidr.ac.in

इ-टेंडर नोटिस न. **E-Tender Notice No.**

आई. आई. एम. आई. /परियोजना /07/2022/129 फ़ाइल न. 474

IIMI/Project/07/2022/129 File No. 474

तकनीकी व्यावसायिक प्रक्रिया

TECHNO COMMERCIAL PROPOSAL

Name of Work: "Making, Supply & Installation of Furniture /Fixtures in Executive Residence-2 at IIM Indore."

प्रमाणित किया जाता है कि एनआईटी दस्तावेज़ में क्रमिक रूप से 1 से 105 तक 105 पृष्ठ हैं

Certified that the NIT Document contains 105 pages serially numbered from 1 to 105

भारतीय प्रबंध संस्थान इंदौर
INDIAN INSTITUTE OF MANAGEMENT INDORE

अनुक्रमणिका INDEX

क्रमांक Sr. No.	विवरण Contents	पृष्ठ क्र Page No.
	ई - निविदा आमंत्रण सूचना Notice Inviting e-Tender	3
A	महत्वपूर्ण घटनाओं / गतिविधियों की अनुसूची Schedule of Important Events / Activities	3
B	ई-टेंडरिंग के लिए दिशानिर्देश Guidelines for Online Bid Submission Through e-Wizard	6
C	अन्य जानकारी और नियम और शर्तें Other information and terms & conditions	9
D	पात्रता मानदंड, मूल्यांकन और ठेकेदार का चयन Eligibility Criteria, Evaluation and Selection of Contractor	11
E	अपलोड किए जाने वाले दस्तावेजों की सूची List of Documents to be uploaded	14
F	टेंडरर को सामान्य निर्देश General Instructions to tenderers	15
G	भुगतान की शर्तें Terms of Payment	16
H	सुरक्षा कोड Safety Codes	17
I	अग्नि सुरक्षा Fire Safety	17
J	इंटीग्रिटी पैक्ट Integrity Pact	23
K	अनुबंध Agreement	29
L	अनुबंध की सामान्य स्थिति General Condition of Contract	32
M	अनुसूचियों का प्रोफार्मा Proforma of Schedules	72
N	अनुबंध की विशेष शर्तें Special Conditions of Contract	76
O	विभिन्न रूपों / प्रमाण पत्रों के लिए प्रारूप Formats for Different Forms/Certificates	82
P	तकनीकी विनिर्देश, और अनुमोदित निर्माता Technical Specifications, & Approved Makes	86
Q	वित्तीय बोली Financial Bid	95-105

ई - निविदा आमंत्रण सूचना NOTICE INVITING E-TENDER

सन्दर्भ इ-टेंडर नोटिस न. आई. आई. एम. आई. /परियोजना /07/2022/129 फ़ाइल न. 474

Ref: E-Tender Notice No. IIMI/Project/07/2022/129 File No. 474

आईआईएम इंदौर निविदा दस्तावेज में उल्लिखित पात्रता मानदंड के अनुसार पात्र बोलीदाताओं से आईआईएम इंदौर में उल्लिखित कार्य के लिए ई-प्रोक्योरमेंट पोर्टल <https://mhrd.euniwizarde.com> के माध्यम से ऑनलाइन आइटम दर निविदा आमंत्रित करता है। विवरण नीचे दिया गया है:

IIM Indore invites online item rate tender through e-procurement portal of MOE i.e. <https://mhrd.euniwizarde.com> the under mentioned work at IIM Indore from the bidders eligible as per the eligibility criteria mentioned in the tender document. The details are given below:

A.	महत्वपूर्ण घटनाओं / गतिविधियों की अनुसूची Schedule of Important Events / Activities
-----------	--

A.1 बोली से संबंधित जानकारी Information Related to Bid

A.1.1	एन आई टी न. : आई. आई. एम. आई. /परियोजना /07/2022/129 फ़ाइल न. 474 NIT No. : IIMI/Project/07/2022/129 File No. 474		
A.1.2	<table border="1"> <tr> <td style="text-align: center;">About the Institute</td> <td>IIM Indore is located on Rau Pithampur Road, 25 km away from main city centre. Our is an ethical Institution and we believe in transparency in every facets of work. There is least interference other than quality assurance and timely delivery. There is no need to interact with anyone other than concerned engineer. No material will be allowed to enter the campus from Security gate without passing the same by concerned engineer following technical specifications of the tender. There will be joint measurement of works when completed and bill will be submitted after the joint measurement is accepted. The payment will be made online without any contact with anybody. Strict quality control will be ensured for the job to be executed as per technical specification and make/brand of materials (in case of any brand or its equivalent specified, sample have to approved in advance).</td> </tr> </table>	About the Institute	IIM Indore is located on Rau Pithampur Road, 25 km away from main city centre. Our is an ethical Institution and we believe in transparency in every facets of work. There is least interference other than quality assurance and timely delivery. There is no need to interact with anyone other than concerned engineer. No material will be allowed to enter the campus from Security gate without passing the same by concerned engineer following technical specifications of the tender. There will be joint measurement of works when completed and bill will be submitted after the joint measurement is accepted. The payment will be made online without any contact with anybody. Strict quality control will be ensured for the job to be executed as per technical specification and make/brand of materials (in case of any brand or its equivalent specified, sample have to approved in advance).
About the Institute	IIM Indore is located on Rau Pithampur Road, 25 km away from main city centre. Our is an ethical Institution and we believe in transparency in every facets of work. There is least interference other than quality assurance and timely delivery. There is no need to interact with anyone other than concerned engineer. No material will be allowed to enter the campus from Security gate without passing the same by concerned engineer following technical specifications of the tender. There will be joint measurement of works when completed and bill will be submitted after the joint measurement is accepted. The payment will be made online without any contact with anybody. Strict quality control will be ensured for the job to be executed as per technical specification and make/brand of materials (in case of any brand or its equivalent specified, sample have to approved in advance).		
A.1.3	<table border="1"> <tr> <td style="text-align: center;">कार्य का नाम Name of Work</td> <td>“Making, Supply & Installation of Furniture /Fixtures in Executive Residence-2 at IIM Indore.</td> </tr> </table>	कार्य का नाम Name of Work	“Making, Supply & Installation of Furniture /Fixtures in Executive Residence-2 at IIM Indore.
कार्य का नाम Name of Work	“Making, Supply & Installation of Furniture /Fixtures in Executive Residence-2 at IIM Indore.		
A.1.4	<table border="1"> <tr> <td style="text-align: center;">निविदा की प्राकल्पित राशि (गुड्स एंड सर्विस टैक्स सहित)</td> <td>Rs. 2,51,86,754/- (Rupees Two Crore Fifty One Lakh Eighty Six Thousand Seven Hundred and Fifty Four Only)</td> </tr> </table>	निविदा की प्राकल्पित राशि (गुड्स एंड सर्विस टैक्स सहित)	Rs. 2,51,86,754/- (Rupees Two Crore Fifty One Lakh Eighty Six Thousand Seven Hundred and Fifty Four Only)
निविदा की प्राकल्पित राशि (गुड्स एंड सर्विस टैक्स सहित)	Rs. 2,51,86,754/- (Rupees Two Crore Fifty One Lakh Eighty Six Thousand Seven Hundred and Fifty Four Only)		

	Estimated Cost Put to Tender (Including Goods & Service Tax)	
A.1.5	ईएमडी Earnest Money Deposit (EMD) (in Rs.)	<p>Rs. 5,03,735 /- (Rs. Five Lakh Three Thousand Seven Hundred Thirty Five Only) by e-payment through electronic mode (NEFT/ RTGS)</p> <p>Note:</p> <ol style="list-style-type: none"> EMD shall be refunded after the selection process is over. Normally in case of unsuccessful bidders it gets refunded on or before the 30th day after the award of the contract. The EMD deposited along with bid by the successful bidder shall be returned after receiving the requisite performance guarantee. EMD may be forfeited <ul style="list-style-type: none"> if any bidder withdraw or modify their Bids during the period of validity, or if the successful bidder after being awarded the contract, fail to sign the contract, or to submit a performance Guarantee before the deadline defined in the NIT or as per the instruction of IIM Indore, whichever is later. In this case the action of forfeiture shall be undertaken without any notice. Also, the bidder shall not be allowed to participate in the re-tendering process of the services. Along with the aforesaid, they will be suspended for the period of two years from being eligible to submit Bids for contracts with the IIM Indore.
A.1.6	समापन की अवधि Completion period	60 Days
A.1.7	निविदा जमा करने की विधि Mode of submission of tender	केवल ऑन-लाइन मोड On-Line mode only

A.2 प्रमुख घटनाएँ और तिथियाँ Key Events and Dates

A.2.1	प्रकाशित करने का दिनांक Publishing Date	June 03, 2022
A.2.2	Pre-Bid Meeting	June 9th, 2022 at 3:00 PM Address of Pre-bid: Conference room, 2nd floor Administrative Block at IIM Indore. (You have to request for entry permission in advance through email

		on projectdept@iimidr.ac.in on or before June 08, 2022)
A.2.3	Uploading of clarifications on queries	By June 10, 2022 on IIM Indore website
A.2.4	दस्तावेज सहित निविदा के ऑनलाइन जमा करने की अंतिम तिथि और समय Last date and time of closing of uploading/online submission of tender	Upto 03:00 PM of June 16, 2022
A.2.5	तकनीकी बोली के ऑनलाइन खोलने की तिथि और समय Date & Time of online opening of technical bid	03:30 PM of June 16, 2022
A.2.6	योग्य बोलीदाताओं की वित्तीय बोली खोलने की तिथि और समय Date and Time of opening of financial bid of qualified bidders	बाद में सूचित किया जाएगा Will be notified later

A.3 बोली से संबंधित अन्य महत्वपूर्ण जानकारी Other Important Information Related to Bid

A.3.1	प्रतिभूति जमा Security Deposit	2.5 % of tendered value (professional fees) to be recovered from running bills of professional fee. Alternatively, Bank Guarantee (BG) OR fixed deposit receipts from a scheduled bank may be submitted, to be payable at Indore. And it must be valid upto 60 days after date of completion of project or as per the requirement of the job.
A.3.2	परफॉर्मन्स गारंटी Performance Guarantee	3 % of tendered value (professional fees) on acceptance of bid. The performance guarantee may be submitted in the form of bank guarantee OR demand draft OR fixed deposit receipt from a scheduled bank which shall be refunded after 60 days of completion of work as per complete scope of this NIT/issue of completion certificate whichever is later.
A.3.3	बोली की वैधता Bid Validity	निविदा खोलने की तिथि से 90 दिन 90 Days from the date of opening of tender
A.3.4	Method of Selection	Quality and Cost Based Selection

Important Note: the bidders may visit the actual site to understand the actual condition/ material of all the buyback furniture items before submission of their bids & it will be as is where is basis.

B.**Guidelines for Online Bid Submission Through e-Wizard
(As per the requirement given to IIM Indore by e-Wizard)****B.1 Instructions for Online Bid Submission through MOE e-Bidding Portal:**

The bidders are required to submit soft copies of their bids electronically on the e-wizard Portal, using valid Digital Signature Certificates. The instructions given below are meant to assist the bidders in registering on the e-Procurement Portal <https://mhrd.euniwizarde.com>, prepare their bids in accordance with the requirements and submitting their bids online on the e- Procurement Portal.

More information useful for submitting online bids on the e-Procurement Portal may be obtained at: <https://mhrd.euniwizarde.com>

B.2 REGISTRATION

1. Bidders are required to enroll on the e-Procurement Portal (<https://mhrd.euniwizarde.com>) by clicking on the link “Bidder Enrollment” on the e-wizard Portal by paying **the non-refundable Registration fee of Rs. 2000/- plus GST per year charge.**
2. As part of the enrolment process, the bidders will be required to choose a unique user name and assign a password for their accounts.
3. Bidders are advised to register their valid email address and mobile numbers as part of the registration process. These would be used for any communication with the bidder.
4. Upon enrolment, the bidders will be required to register their valid Digital Signature Certificate (Only Class III Certificates with signing + encryption key usage) issued by any Certifying Authority recognized by CCA India (e.g. Capricorn / Sify / TCS / nCode / eMudhra etc.), with their profile.
5. Only one valid DSC should be registered by a bidder. Please note that the bidders are responsible to ensure that they do not lend their DSC’s to others which may lead to misuse.
6. Bidder then logs in to the site through the secured log-in by entering their user ID/password and the password of the DSC / e-Token.
7. The scanned copies of all original documents should be uploaded on portal.

For any Query contact to our helpdesk Number 011-49606060, Email: helpdeskeuniwizarde@gmail.com, Mr. Deepak Jha 08448288981.

B.3 SEARCHING FOR BIDDING DOCUMENTS

1. There are various search options built in the e-bid Portal, to facilitate bidders to search active bids by several parameters. These parameters could include Bid ID, Item/work id, Title, Date, etc
2. Once the bidders have selected the bids they are interested in, the bidder can pay **the non-refundable tender processing fee i.e. Rs. 8,850 /- (Rupees Eight Thousand Eight hundred Fifty Only) including GST in the favor of M/s ITI Ltd.** by net-banking / Debit / Credit card and then download the required documents / bid schedules, Bid documents etc as mentioned on website. Once processing fee is paid, it will be moved to the respective “requested” Tab. This would enable the e-bid Portal to intimate the bidders through e-mail in case there is any addendum and corrigendum issued to the bidding document.

B.4 PREPARATION OF BIDS

1. Bidder should take into account any addendum and corrigendum published on the bid document before submitting their bids only on e-procurement portal (<https://mhrd.euniwizarde.com>).
2. Please go through the bid advertisement and the bid document carefully to understand the documents required to be submitted as part of the bid. Please note the number of covers in which the bid documents have to be submitted, the number of documents - including the names and content of each of the document that need to be submitted. Any deviations from these may lead to rejection of the bid.
3. Bidder, in advance, should get ready the bid documents to be submitted as indicated in the bid document / schedule and generally, they can be in PDF /JPEG formats. Bid Original documents may be scanned with 100 dpi with Colored option which helps in reducing size of the scanned document.
4. To avoid the time and effort required in uploading the same set of standard documents which are required to be submitted as a part of every bid, a provision of uploading such standard documents (e.g. PAN card copy, annual reports, auditor certificates etc.) has been provided to the bidders. Bidders can use “My Documents” available to them to upload such documents.
5. These documents may be directly submitted from the “My Documents” area while submitting a bid, and need not be uploaded again and again. This will lead to a reduction in the time required for bid submission process.

B.5 SUBMISSION OF BIDS

1. Bidder should log into the website well in advance for the submission of the bid so that it gets uploaded well in time i.e. on or before the bid submission time. Bidder will be responsible for any delay due to other issues.
2. The bidder has to digitally sign and upload the required bid documents one by one as indicated in the bidding document.
3. Bidder has to select the payment option as “Online mode or Bank Guarantee” as to pay the EMD as applicable and enter details of the instrument.
4. In case of Bank Guarantee scanned copy of BG should be uploaded along with bid. . The original Bank Guarantee shall be submitted to office of the concerned official as per schedule mentioned in the bid document. Non submission of original Bank Guarantee within the specified period shall lead to summary rejection of bid. The details of the BG , physically submitted should match with the details available in the scanned copy and the data entered during bid submission time. Otherwise bid will be rejected.
5. Bidders are requested to note that they should necessarily submit their financial bids in the format provided and no other format is acceptable. If the price bid has been given as a standard BoQ format with the bid document, then the same is to be downloaded and to be filled by all the bidders. Bidders are required to download the BoQ file, open it and complete (unprotected) cells with their respective financial quotes and other details (such as name of the bidder). No other cells should be changed. Once the details have been completed, the bidder should save it and submit it online, without changing the filename. If the BoQ file is found to be modified by the bidder, the bid will be rejected.
6. The server time (which is displayed on the bidders dashboard) will be considered as the standard time for referencing the deadlines for submission of the bids by the bidders, opening of bids etc. The bidders should follow this time during bid submission.
7. All the documents being submitted by the bidders would be encrypted using PKI encryption techniques to ensure the secrecy of the data. The data entered cannot be viewed by unauthorized persons until the time of bid opening. Data storage

encryption of sensitive fields is done. Any bid document that is uploaded to the server is subjected to symmetric encryption using a system generated symmetric key. Further this key is subjected to asymmetric encryption using buyers/bid opener public keys. Overall, the uploaded bid documents become readable only after the bid opening by the authorized bid openers.

8. The uploaded bid documents become readable only after the bid opening by the authorized bid openers.
9. Upon the successful and timely submission of bid click “Complete“ (i.e. after Clicking “Submit” in the portal), the portal will give a successful Bid submission acknowledgement & a bid summary will be displayed with the unique id and date & time of submission of the bid with all other relevant details.
10. The bid summary has to be printed and kept as an acknowledgement of bid submission.

B.6 ASSISTANCE TO BIDDERS

For any Query contact to our helpdesk Number 011-49606060, Email ewizardhelpdesk@gmail.com , Mr. Siddharth 09355030604. It is mandatory for all the applicants to have class II or III digital signature certification from licensed certifying agency like NIC, MTNL, e-mudra, TCS, safescrypt, GNFC etc.

C. Other information and terms & conditions

- C.1 The bid submitted shall become invalid:
- If the bidder is found ineligible.
 - If any of the bidder put his quoted rates (as in financial bid document) in the envelope of Cover-I: Technical Bid.
 - If the documents submitted by the successful bidder does not match with the originals before the award of work.
- C.2 However, certified copy of all the scanned and uploaded documents as specified in NIT shall have to be submitted by the lowest bidder only within a week physically in the office of the “Chief Engineer, Indian Institute of Management Indore, Prabandh Shikhar, Rau - Pithampur Road, Indore 453556 (M.P.).
- C.3 IF ANY INFORMATION FURNISHED by the applicant is found to be incorrect at a later stage, they shall be liable to be debarred from tendering/ taking up works in IIM INDORE.
- C.4 The competent authority on behalf of the Director IIM Indore does not bind itself to accept the lowest or any other bid and reserves to itself the authority to reject any or all the bids received without the assignment of any reason. All bids in which any of the prescribed condition is not fulfilled or any condition including that of conditional rebate is put forth by the bidders shall be summarily rejected.
- C.5 Canvassing whether directly or indirectly, in connection with bidders is strictly prohibited and the bids submitted by the contractors who resort to canvassing will be liable for rejection.
- C.6 The competent authority on behalf of the Director, IIM Indore reserves to himself the right of accepting the whole or any part of the bid and the bidders shall be bound to perform the same at the rate quoted.
- C.7 *The bid for the works shall remain open for acceptance for a period of Ninety (90) days from the date of opening of technical bid.* If any bidders withdraws his bid before the said period or issue of letter of acceptance, whichever is earlier, or makes any modifications in the terms and conditions of the bid which are not acceptable to the department, then the IIM Indore shall, without prejudice to any other right or remedy, be at liberty to suspend the bidder for two years.
- C.8 This notice inviting Bid shall form a part of the contract document. The successful bidders/contractor, on acceptance of his bid by the Accepting Authority shall within 15 days from the stipulated date of start of the work, sign the contract consisting of:-
- The Notice Inviting Bid, all the documents including additional conditions, specifications, General Conditions of Contract and drawings, if any, forming part of the bid as uploaded at the time of invitation of bid and the rates quoted online at the time of submission of bid and acceptance thereof together with any correspondence leading thereto.
 - Any other Standard C.P.W.D. Form /other forms as applicable/ mentioned.

C.9 TAXES: -

- i) The Contractor should get registered under GST and tax as applicable as per the extant order on the subject work shall be paid by the contractor to concerned department. Which will be reimbursed by the Institute as per the recommendation of Finance & Accounts department of the Institute & the same will be final & binding to the contractor.**
- ii) The quote should Include the GST and inclusive of all other taxes applicable for the subject work. GST will be paid extra as applicable.**
- iii) Labour Welfare cess @ 1 % of gross value of work done shall be recovered from each bill paid to the contractor.**
- iv) Income Tax and cess as applicable shall be deducted from bill paid to the contractor.**
- v) Contractor should be registered under EPF and as per law, shall pay EPF of contract workers to concerned Department from time to time.**
- vi) Any other taxes/cess as per Government directives shall be deducted from each bill paid to the contractor from time to time.**

C.10 The specifications, Terms & Conditions, other regulations which are not herein mentioned will be guided by manual for procurement of works from ministry of finance & department of expenditure of Govt. of India, relevant CPWD guidelines, manual, specifications / BIS / IS/ Other Central / State Govt. norms applicable for IIM Indore & as prescribed by the OEM and the decision in this regard will be guided by the decision of the respective authority (Director/ Chief Engineer as per applicability) of IIM Indore which shall be final and binding to the contractor.

C.11 Tender documents may be downloaded from IIM Indore's website/ CPPP e-Publishing portal free of cost.

C.12 Tenders and supporting documents should be uploaded through eprocurement portal i.e. e-Wizard only. Hard copy of the tender documents will not be accepted.

C.13 In the event of acceptance of a tender or as per the decision of the competent authority of IIM Indore, the documents submitted by the bidder/ successful bidder shall be verified with the originals before the award of work.

C.14 On acceptance of the tender, the tenderer has to furnish a bar chart showing work completion schedule and submit it along with the performance security guarantee.

C.15 The tenderer should not have been blacklisted or debarred by any Central/ State/ Autonomous/ Public Agency during last three financial years. In case blacklisted/ debarred bidder fills/ submits the bid/ being successful in bidding process awarded the job or during the execution of job the fact of being blacklisted/ debarred surfaced then the

- Bid (during the bidding process) will be considered as invalid &**
- During the execution, if surfaced, then the contract will be liable to be terminated**

D.

Eligibility Criteria, Evaluation and Selection of Contractor

a. **Minimum Eligibility Criteria:** Prospective bidder should have the following for making oneself eligible for participation in the bidding process (Joint Ventures are not allowed):

1. **Work Experience:** Experience of having successfully completed works (Furniture Work) during the last 7 years ending previous day of last date of submission of tenders as under.

One completed work (Furniture Work) of aggregate cost not less than the amount equal to 80% i.e. **Rs. 2,01,49,403 /-** of the estimated cost put to tender.

OR

Two completed works (Furniture Work) each costing not less than the amount equal to 50% i.e. **Rs. 1,25,93,377 /-** of the estimated cost put to tender.

OR

Three completed works (Furniture Work) each costing not less than the amount equal to 40% i.e. **Rs. 1,00,74,702 /-** of estimated cost put to tender.

Note: The completion certificate issued from clients should indicate the date of commencement, period of completion- stipulated & actual, awarded cost & cost at completion, quality of work done, reason for delay (if any) etc.

2. **Annual Financial Turnover:** Annual financial turnover should be at least 50% i.e. **Rs. 1,25,93,377 /-** (**Rupees One Crore Twenty Five Lakh Ninety Three Thousand Three Hundred Seventy Seven Only**) of the estimated cost put to tender for FY 2020-21. (scanned copy of original certificate from CA having UDIN Number to be uploaded)
3. **Profit/loss :** The bidders which had been profit making in any two years during the last three financial years 2018-19, 2019-20, 2020-21 (to be supported by audited profit & loss account).
4. **Solvency Certificate:** Solvency certificate from scheduled bank for an amount equal to 40% i.e. **Rs. 1,00,74,702 /-** (**Rupees One Crore Seventy Four Thousand Seven Hundred Two Only**) of the Estimated Cost put to tender. (Date of issue should be during the period of this tender submission or else the validity period should be mentioned on the Solvency Certificate & this should cover up the tender submission period)
5. **Certificates:** (scanned copy of original certificates to be uploaded)
 - 5.1 PAN (Permanent Account Number)
 - 5.2 GST (Goods & Service Tax) Registration Certificate (in Active status)
 - 5.3 E-payment details towards EMD.
6. **Past performance in IIM Indore:** Bidder, whose past performance in jobs carried out in IIM, is found to be unsatisfactory, will be disqualified technically even though they may meet the other technical/eligibility criteria.

b. OVERALL EVALUATION PROCESS & SELECTION OF CONTRACTOR:

Bidding Process will be a two-bid system which comprises of technical bid and financial bid. Further the technical bid will be subdivided into two stages namely technical bid stage-1 and technical bid stage-2. The ratio of weightages for cost (financial) and technical score will be 70:30 (Seventy : Thirty).

The Method of selection will be Quality and Cost Based Selection (QCBS). As is said earlier the Technical bid will be evaluated in two stages, stage-1 will be based on minimum eligibility criteria required in respect of bidder's work experience & credentials whereas technical bid stage - 2 would be based on bidder's organizational structure, staffing, production capacity, quality assurance mechanism in place & local establishment and the same will be evaluated through the presentation submitted by bidder. After that the financial bid will be opened for the qualified bidders of the respective stage only. The weightage would be as follows.

i. Technical Bid

- Stage-1 (Bidder's work experience/ credentials) viz. minimum eligibility based on the criteria given at page 11 of 105 of NIT Document. For this no marks will be allocated towards final evaluation but this will be considered as mandatory for making oneself eligible to participate in the subsequent bidding process.
- Stage-2 (Comprising of bidder's organizational structure, staffing, production capacity, quality assurance mechanism in place & local establishment) : Weightage 30% (based on presentation)

ii. Financial Bid (i.e. cost) =70%

The bidder scoring the highest marks after final evaluation will be considered for selection of a contractor after due negotiation of cost, if required.

Note:

i. The broad methodology brief is as follows:

“Proposal with the lowest cost may be given a financial score of 100 (Hundred) and other proposals given financial scores that are inversely proportional to their prices w.r.t. the lowest offer.

Similarly, proposal with the highest technical marks (as allotted by the evaluation committee) shall be given a score of 100 (Hundred) and other proposals be given technical score that are proportional to their marks w.r.t. the highest technical marks. The total score, both technical and financial, shall be obtained by weighing the quality and cost scores and adding them up. On the basis of the combined weighted score for quality and cost, the contractor shall be ranked in terms of the total score obtained. The proposal obtaining the highest total combined score in evaluation of quality and cost will be ranked as H-1 followed by the proposals securing lesser marks as H-2, H-3 and so on. The proposal securing the highest combined marks and ranked H-1 will be invited for negotiations, if required and shall be recommended for award of contract.”

ii. In the event two or more bids have the same score in final ranking, the bid with highest technical score will be H-1.

c. Details of marking & evaluation methodology:

c.1 TECHNICAL BID (STAGE-1)

The bidder will be shortlisted based on minimum eligibility criteria given at page 11 of 105 of NIT Document. For this no marks will be allocated towards final evaluation but this will be considered as mandatory for participation in the subsequent bidding process.

c.2 Technical bid (STAGE-2)

All those bidders who gets qualified in the Evaluation of Technical Bid (stage-1) will be eligible to participate in stage-2. The evaluation in this stage shall be based on presentation submitted by the bidder. The presentation shall be comprising of bidder's organizational structure, staffing, production capacity, quality assurance mechanism in place & local establishment for which weightage to be given as 30% towards final evaluation.

The evaluation committee may call the bidders for making presentation, if required. If called, the bidder shall have to arrange his/ her own logistics for participation and the financial implication also need to be borne by them only. The evaluation committee may undertake visits for verification.

The marking shall depend on submitted presentation, presentation before the Committee constituted for the purpose (If applicable) and verification (If applicable).

Parameter wise marking system is as under:

Sl. No.	Criteria		Maximum Marks
i)	Presentation	<ul style="list-style-type: none"> - organisational structure - staff strength <ul style="list-style-type: none"> • in office and • in furniture manufacturing units (one or more - what quality assurance mechanism followed in the factory - monthly production capacity of following items - <ul style="list-style-type: none"> (i) beds (both single & double) (ii) study table / other tables (iii) chairs (iv) wardrobes - max. value of single work order (one or more) executed within stipulated time of contract with names of clients, address and contact number (certificate from client to be provided). - max. value of single work order (one or more) executed with extended period of time (delay attributable to contractor, completion certificate from client mentioning reason for delay must be submitted) - capability of how much value of the tendered job, can be executed without asking for RA Bill payment. 	20

ii)	Local office / factory	Office/ Factory located in Indore district or Pithampur	10
Total Marks			30

c.3 Financial bid: The weightage of marks scored in the financial bid shall contribute 70% towards the final evaluation.

E. List of Documents to be uploaded

While submitting bid, the following documents are to be uploaded:

For Cover-1:

- i) NIT Document duly sign & sealed on each page to be scan and uploaded.
- ii) Certificates of Work Experience: Experience of having successfully completed works during the last 7 years ending previous day of last date of submission.
- iii) Copy of CA certificate having UDIN number for annual financial turnover to be uploaded
- iv) Audited copy of profit & loss account
- v) Copy of current solvency certificate
- vi) Technical staff: List of technical staff they possess and proposed to deploy for the work to be uploaded
- vii) Certification of Incorporation/ Registration of firm
- viii) PAN (Permanent Account Number)
- ix) GST (Goods and Services Tax) Registration Certificate
- x) Latest IT Return
- xi) E-payment details towards EMD
- xii) Presentation prepared by bidder
- xiii) EPF & ESI registration certificates (if applicable)
- xiv) Govt. Id proof of the person who will sign the contract agreement
- xv) Bank Account details

For Cover-2:

- i) Schedule of Price Bid in the form of .xls

F. General Instructions to Tenderers

1. Scope of Work

The scope of work shall include the following.

- a. Making, supply & installation of furniture/ fixtures of all the items as detailed in Bill of Quantity and technical specifications all complete work and as mentioned in the tender & as per the direction of Engineer-in-Charge.
- b. Any other work related to but not specifically mention above, required for completion of the job as per the intent and scope of work.

2. The Tenderer shall get acquainted with the location of the sites and carefully check the specifications and shall satisfy himself that the material / items offered is complying with the IIM Indore's requirements and specifications laid down in the tender document or as per the direction of Engineer-in-Charge.

3. Inspection of materials/work at site

The IIM Indore's engineer and /or his representative shall inspect the materials at site after delivery before the same is used in the work. The IIM's engineer and /or his representative shall have free and full access at any time during execution of the contract to the contractor's works or site. In case of execution of work for the aforesaid purpose, and IIM's engineer may require the contractor to make arrangements for inspection of work or any part thereof or any material at his premises or at any other place specified by the IIM Indore's Engineer.

4. The IIM Indore's Engineer shall have the power-

- i) To reject the whole/part of the items/ materials/ equipments tendered for inspection, if after inspection of such portion thereof, as he may in his discretion think fit, he is satisfied that the same is unsatisfactory; and
- ii) To mark the rejected items / materials or parts with a rejection mark so that it may easily be identified if re-submitted.

5. Maintenance & Guarantee/ Warranty:

- a. The rate quoted should be inclusive of charges of all the works & respective associated accessories including SITC of the materials/ equipments at earmarked / specified locations including maintenance during Defect Liability Period of 01 (ONE) year.
- b. The warranty/ guarantee of the equipments will be guided by the respective items detailing/ specified in the BoQ/ tender. And the release of Performance Guarantee will depend & guided by the respective CPWD stipulations for the said items/ equipments.
- c. During the Defect Liability Period, IIM Indore reserve the right to cross check the performance of any item / material with the minimum performance levels specified in the specifications.
- d. Any damage of the existing structure, building etc. made by the successful bidder during execution of this work shall be made good as it was at his own cost & risk and to the satisfaction of Engineer-in-Charge.

G. Terms of Payment

Terms of Payment for the work

The following terms of payment shall be applicable. No variation in the terms of payment will be acceptable. Further, as per Indian laws, income tax, any other tax as applicable shall be deducted at source from the bills and a certificate for the same will be issued to the contractor.

Payment shall be made by IIM Indore to the contractor each month on or before the date fixed by the Engineer-in-Charge for all works executed in previous months. The contractor shall prepare computerized bills. The Contractor shall submit three numbers of hard copies and one soft copy of CD (non-rewritable) & Pendrive for all bills. All running payments shall be regarded as payments by way of advance against the final payment only and not as payments for work actually done and completed and / or accepted by IIMI and shall not preclude the recovery for bad, unsound and imperfect or unskilled work to be removed and taken away and reconstructed or re-erected or be considered as an admission of the due performance of the Contract, or any part thereof, in this respect, or the accruing of any claim, nor shall it conclude, determine or affect in any way the powers of the IIMI under these conditions or any of them as to the final settlement and adjustments of the accounts or otherwise, or in any other way vary/ affect the contract.

Note:

- Contractors should have financial capability to finance the project on their own without waiting for RA Bill payment from IIM Indore to progress on job.
- No mobilisation advances shall be paid to the contractor.
- Secured advance of 75 % of value of materials delivered, based on supplier's invoice to contractor, will be paid on request with all supporting documents..
- RA Bills will be paid based on approximate measurement of the BoQ item-wise job carried out at site, supported by MB entry and certification of the Engineer of the quantity recommended for payment. Detailed measurement of item-wise job carried out with full measurement required for final bill only.
- Only one RA Bill will be accepted in a month.
- All efforts will be made to release payment for RA Bills within 15 days of receipt with all supporting documents.

I. Safety Codes

- 1 Suitable scaffolds should be provided for workmen for all works that cannot safely be done from the ground, or from solid construction except such short period work as can be done safely from ladders. When a ladder is used, an extra mazdoor shall be engaged for holding the ladder and if the ladder is used for carrying materials as well suitable footholds and hand-hold shall be provided on the ladder and the ladder shall be given an inclination not steeper than $\frac{1}{4}$ to 1 ($\frac{1}{4}$ horizontal and 1 vertical.)
- 2 Scaffolding of staging more than 3.6 m (12ft.) above the ground or floor, swung or suspended from an overhead support or erected with stationary support shall have a guard rail properly attached or bolted, braced and otherwise secured at least 90 cm. (3ft.) high above the floor or platform of such scaffolding or staging and extending along the entire length of the outside and ends there of with only such opening as may be necessary for the delivery of materials. Such scaffolding or staging shall be so fastened as to prevent it from swaying from the building or structure.
- 3 Working platforms, gangways and stairways should be so constructed that they should not sag unduly or unequally, and if the height of the platform or the gangway or the stairway is more than 3.6 m (12ft.) above ground level or floor level, they should be closely boarded, should have adequate width and should be suitably fastened as described in (2) above.
- 4 Every opening in the floor of a building or in a working platform shall be provided with suitable means to prevent the fall of person or materials by providing suitable fencing or railing whose minimum height shall be 90 cm. (3ft.)
- 5 Safe means of access shall be provided to all working platforms and other working places. Every ladder shall be securely fixed. No portable single ladder shall be over 9m. (30ft.) in length while the width between side rails in rung ladder shall in no case be less than 29 cm. (11½") for ladder upto and including 3 m. (10 ft.) in length. For longer ladders, this width should be increased at least $\frac{1}{4}$ " for each additional 30 cm. (1 foot) of length. Uniform step spacing of not more than 30 cm shall be kept. Adequate precautions shall be taken to prevent danger from electrical equipment. No materials on any of the sites or work shall be so stacked or placed as to cause danger or inconvenience to any person or the public. The contractor shall provide all necessary fencing and lights to protect the public from accident and shall be bound to bear the expenses of defence of every suit, action or other proceedings at law that may be brought by any person for injury sustained owing to neglect of the above precautions and to pay any damages and cost which may be awarded in any such suit; action or proceedings to any such person or which may, with the consent of the contractor, be paid to compensate any claim by any such person.
 - a) Excavation and Trenching - All trenches 1.2 m. (4ft.) or more in depth, shall at all times be supplied with at least one ladder for each 30 m. (100 ft.) in length or fraction thereof, Ladder shall extend from bottom of the trench to at least 90 cm. (3ft.) above the surface of the ground. The side of the trenches which are 1.5 m. (5ft.) or more in depth shall be stepped back to give suitable slope or securely held by timber bracing, so as to avoid the danger of sides

collapsing. The excavated materials shall not be placed within 1.5 m. (5ft.) of the edges of the trench or half of the depth of the trench whichever is more. Cutting shall be done from top to bottom. Under no circumstances, undermining or undercutting shall be done.

b) Safety Measures for digging bore holes:-

- i. If the bore well is successful, it should be safely capped to avoid caving and collapse of the bore well. The failed and the abandoned ones should be completely refilled to avoid caving and collapse;
 - ii. During drilling, Sign boards should be erected near the site with the address of the drilling contractor and the Engineer in-charge of the work;
 - iii. Suitable fencing should be erected around the well during the drilling and after the installation of the rig on the point of drilling, flags shall be put 50m around the point of drilling to avoid entry of people;
 - iv. After drilling the borewell, a cement platform (0.50m x 0.50m x 1.20m) 0.60m above ground level and 0.60m below ground level should be constructed around the well casing;
 - v. After the completion of the borewell, the contractor should cap the bore well properly by welding steel plate, cover the bore well with the drilled wet soil and fix thorny shrubs over the soil. This should be done even while repairing the pump;
 - vi. After the borewell is drilled the entire site should be brought to the ground level.
- 6 Demolition - Before any demolition work is commenced and also during the progress of the work,
- i. All roads and open areas adjacent to the work site shall either be closed or suitably protected.
 - ii. No electric cable or apparatus which is liable to be a source of danger or a cable or apparatus used by the operator shall remain electrically charged.
 - iii. All practical steps shall be taken to prevent danger to persons employed from risk of fire or explosion or flooding. No floor, roof or other part of the building shall be so overloaded with debris or materials as to render it unsafe.
- 7 All necessary personal safety equipment as considered adequate by the Engineer-in-Charge should be kept available for the use of the person employed on the site and maintained in a condition suitable for immediate use, and the contractor should take adequate steps to ensure proper use of equipment by those concerned:- The following safety equipment shall invariably be provided.
- i. Workers employed on mixing asphaltic materials, cement and lime mortars shall be provided with protective footwear and protective goggles.
 - ii. Those engaged in white washing and mixing or stacking of cement bags or any material which is injurious to the eyes, shall be provided with protective goggles.
 - iii. Those engaged in welding works shall be provided with welder's protective eyeshields.

- iv. Stone breaker shall be provided with protective goggles and protective clothing and seated at sufficiently safe intervals.
- v. When workers are employed in sewers and manholes, which are in active use, the contractors shall ensure that the manhole covers are opened and ventilated atleast for an hour before the workers are allowed to get into the manholes, and the manholes so opened shall be cordoned off with suitable railing and provided with warning signals or boards to prevent accident to the public. In addition, the contractor shall ensure that the following safety measure are adhered to :-
 - a. Entry for workers into the line shall not be allowed except under supervision of the JE or any other higher officer.
 - b. At least 5 to 6 manholes upstream and downstream should be kept open for at least 2 to 3 hours before any man is allowed to enter into the manhole for working inside.
 - c. Before entry, presence of Toxic gases should be tested by inserting wet lead acetate paper which changes colour in the presence of such gases and gives indication of their presence.
 - d. Presence of Oxygen should be verified by lowering a detector lamp into the manhole. In case, no Oxygen is found inside the sewer line, workers should be sent only with Oxygen kit.
 - e. Safety belt with rope should be provided to the workers. While working inside the manholes, such rope should be handled by two men standing outside to enable him to be pulled out during emergency.
 - f. The area should be barricaded or cordoned off by suitable means to avoid mishaps of any kind. Proper warning signs should be displayed for the safety of the public whenever cleaning works are undertaken during night or day.
 - g. No smoking or open flames shall be allowed near the blocked manhole being cleaned.
 - h. The malba obtained on account of cleaning of blocked manholes and sewer lines should be immediately removed to avoid accidents on account of slippery nature of the malba.
 - i. Workers should not be allowed to work inside the manhole continuously. He should be given rest intermittently. The Engineer-in-Charge shall decide the time up to which a worker may be allowed to work continuously inside the manhole.
 - j. Gas masks with Oxygen Cylinder should be kept at site for use in emergency.
 - k. Air-blowers should be used for flow of fresh air through the manholes. Whenever called for, portable air blowers are recommended for ventilating the manholes. The Motors for these shall be vapour proof and of totally enclosed type. Non sparking gas engines also could be used but they should be placed at least 2 metres away from the opening and on the leeward side protected from wind so that they will not be a source of friction on any inflammable gas that might be present.
 - l. The workers engaged for cleaning the manholes/sewers should be properly trained before allowing to work in the manhole.

- m. The workers shall be provided with Gumboots or non-sparking shoes bump helmets and gloves non sparking tools safety lights and gas masks and portable air blowers (when necessary). They must be supplied with barrier cream for anointing the limbs before working inside the sewer lines.
 - n. Workmen descending a manhole shall try each ladder stop or rung carefully before putting his full weight on it to guard against insecure fastening due to corrosion of the rung fixed to manhole well.
 - o. If a man has received a physical injury, he should be brought out of the sewer immediately and adequate medical aid should be provided to him.
 - p. The extent to which these precautions are to be taken depend on individual situation but the decision of the Engineer-in-Charge regarding the steps to be taken in this regard in an individual case will be final.
 - vi. The Contractor shall not employ men and women below the age of 18 years on the work of painting with products containing lead in any form. Wherever men above the age of 18 are employed on the work of lead painting, the following precaution should be taken:-
 - a. No paint containing lead or lead products shall be used except in the form of paste or ready made paint.
 - b. Suitable face masks should be supplied for use by the workers when paint is applied in the form of spray or a surface having lead paint is dry rubbed and scrapped.
 - c. Overalls shall be supplied by the contractors to the workmen and adequate facilities shall be provided to enable the working painters to wash during and on the cessation of work.
 - vii. Workmen executing work on scaffolds or other structures above specified height shall be provided with full body harness and fall arresters.
- 8 An additional clause (viii)(i) of Central Public Works Department Safety Code (iv) the Contractor shall not employ women and men below the age of 18 on the work of painting with product containing lead in any form, wherever men above the age of 18 are employed on the work of lead painting, the following principles must be observed for such use :
- i. White lead, sulphate of lead or product containing these pigment, shall not be used in painting operation except in the form of pastes or paint ready for use.
 - ii. Measures shall be taken, wherever required in order to prevent danger arising from the application of a paint in the form of spray.
 - iii. Measures shall be taken, wherever practicable, to prevent danger arising out of from dust caused by dry rubbing down and scraping.
 - iv. Adequate facilities shall be provided to enable working painters to wash during and on cessation of work.
 - v. Overall shall be worn by working painters during the whole of working period.
 - vi. Suitable arrangement shall be made to prevent clothing put off during working hours being spoiled¹³ by painting materials.

- vii. Cases of lead poisoning and suspected lead poisoning shall be notified and shall be subsequently verified by medical man appointed by competent authority of C.P.W.D PWD(DA).
 - viii. C.P.W.D./PWD (DA) may require, when necessary medical examination of workers.
 - ix. Instructions with regard to special hygienic precautions to be taken in the painting trade shall be distributed to working painters.
- 9 When the work is done near any place where there is risk of drowning, all necessary equipments should be provided and kept ready for use and all necessary steps taken for prompt rescue of any person in danger and adequate provision, should be made for prompt first aid treatment of all injuries likely to be obtained during the course of the work.
- 10 Use of hoisting machines and tackle including their attachments, anchorage and supports shall conform to the following standards or conditions :-
- i.
 - (a) These shall be of good mechanical construction, sound materials and adequate strength and free from patent defects and shall be kept repaired and in good working order.
 - (b) Every rope used in hoisting or lowering materials or as a means of suspension shall be of durable quality and adequate strength, and free from patent defects.
 - ii. Every crane driver or hoisting appliance operator, shall be properly qualified and no person under the age of 21 years should be in charge of any hoisting machine including any scaffolding winch or give signals to operator.
 - iii. In case of every hoisting machine and of every chain ring hook, shackle swivel and pulley block used in hoisting or as means of suspension, the safe working load shall be ascertained by adequate means. Every hoisting machine and all gear referred to above shall be plainly marked with the safe working load. In case of a hoisting machine having a variable safe working load each safe working load and the condition under which it is applicable shall be clearly indicated. No part of any machine or any gear referred to above in this paragraph shall be loaded beyond the safe working load except for the purpose of testing.
 - iv. In case of departmental machines, the safe working load shall be notified by the Electrical Engineer-in-Charge. As regards contractor's machines the contractors shall notify the safe working load of the machine to the Engineer-in-Charge whenever he brings any machinery to site of work and get it verified by the Electrical Engineer concerned.
- 11 Motors, gearing, transmission, electric wiring and other dangerous parts of hoisting appliances should be provided with efficient safeguards. Hoisting appliances should be provided with such means as will reduce to the minimum the risk of accidental descent of the load. Adequate precautions should be taken to reduce to the minimum the risk of any part of a suspended load becoming accidentally displaced. When workers are employed on electrical installations which are already energized, insulating mats, wearing apparel, such as gloves, sleeves and boots as may be necessary should be provided. The worker should not wear any rings, watches and carry keys or other materials which are good conductors of electricity.

- 12 All scaffolds, ladders and other safety devices mentioned or described herein shall be maintained in safe condition and no scaffold, ladder or equipment shall be altered or removed while it is in use. Adequate washing facilities should be provided at or near places of work.
- 13 These safety provisions should be brought to the notice of all concerned by display on a notice board at a prominent place at work spot. The person responsible for compliance of the safety code shall be named therein by the contractor.
- 14 To ensure effective enforcement of the rules and regulations relating to safety precautions the arrangements made by the contractor shall be open to inspection by the Labour Officer or Engineer-in-Charge of the department or their representatives.
- 15 For Electronics works execution relevant safety standard of Govt. of India/ CPWD need to be followed.
- 16 Notwithstanding the above clauses from (1) to (16), there is nothing in these to exempt the contractor from the operations of any other Act or Rule in force in the Republic of India.

J.	Fire Safety
-----------	--------------------

This will be as per the Fire Safety codes of the CPWD to the extent applicable to the IIM Indore. Decision in this regard will be governed by the competent authority of IIM Indore which shall be final and binding to the contractor.

K. Integrity Pact

INTEGRITY PACT

To,

.....,
.....,
.....

Sub: NIT No. IIMI/Project/07/2022/129 File No. 474 for the work of “NIT for Making, Supply & Installation of Furniture /Fixtures in Executive Residence-2 at IIM Indore.”

Dear Sir,

It is here by declared that IIM Indore is committed to follow the principle of transparency, equity and competitiveness in public procurement. The subject Notice Inviting Tender (NIT) is an invitation to offer made on the condition that the Bidder will sign the integrity Agreement, which is an integral part of tender/bid documents, failing which the tenderer/bidder will stand disqualified from the tendering process and the bid of the bidder would be summarily rejected.

This declaration shall form part and parcel of the Integrity Agreement and signing of the same shall be deemed as acceptance and signing of the Integrity Agreement on behalf of the IIM Indore.

Yours faithfully

Chief Engineer

INTEGRITY AGREEMENT

This Integrity Agreement is made at on this day of 2022
BETWEEN

The Director, IIM Indore represented through Chief Engineer, IIM Indore, (Hereinafter referred as the IIM Indore, Prabandh Shikhar, Rau-Pithampur Road, Indore “Principal/Owner”, which expression shall unless repugnant to the meaning or context hereof include its successors and permitted assigns)

AND

.....
..... (Name and Address of the Individual/ firm/ Company)

Through
(Hereinafter referred to as the (Details of duly authorized signatory) “Bidder/Contractor” and which expression shall unless repugnant to the meaning or context hereof include its successors and permitted assigns)

Preamble

WHEREAS the Principal / Owner has floated the Tender IIMI/Project/07/2022/129 File No. 474 (hereinafter referred to as “Tender/Bid”) and intends to award, under laid down organizational procedure, contract for “Making, Supply & Installation of Furniture /Fixtures in Executive Residence-2 at IIM Indore.”. hereinafter referred to as the “Contract”.

AND WHEREAS the Principal/Owner values full compliance with all relevant laws of the land, rules, regulations, economic use of resources and of fairness/transparency in its relation with its Bidder(s) and Contractor(s).

AND WHEREAS to meet the purpose aforesaid both the parties have agreed to enter into this Integrity Agreement (hereinafter referred to as “Integrity Pact” or “Pact”), the terms and conditions of which shall also be read as integral part and parcel of the Tender/Bid documents and Contract between the parties.

NOW, THEREFORE, in consideration of mutual covenants contained in this Pact, the parties hereby agree as follows and this Pact witnesses as under:

Article 1: Commitment of the Principal/Owner

(1) The Principal/Owner commits itself to take all measures necessary to prevent corruption and to observe the following principles:

(a) No employee of the Principal/Owner, personally or through any of his/her family members, will in connection with the Tender, or the execution of the Contract, demand, take a promise for or accept, for self or third person, any material or immaterial benefit which the person is not legally entitled to.

(b) The Principal/Owner will, during the Tender process, treat all Bidder(s) with equity and reason. The Principal/Owner will, in particular, before and during the Tender process, provide to all Bidder(s) the same information and will not provide to any Bidder(s) confidential / additional information through which the Bidder(s) could obtain an advantage in relation to the Tender process or the Contract execution.

(c) The Principal/Owner shall endeavour to exclude from the Tender process any person, whose conduct in the past has been of biased nature.

(2) If the Principal/Owner obtains information on the conduct of any of its employees which is a criminal offence under the Indian Penal code (IPC)/Prevention of Corruption Act, 1988 (PC Act) or is in violation of the principles herein mentioned or if there be a substantive suspicion in this regard, the Principal/Owner will inform the Chief Vigilance Officer and in addition can also initiate disciplinary actions as per its internal laid down policies and procedures.

Article 2: Commitment of the Bidder(s)/Contractor(s)

(1) It is required that each Bidder/Contractor (including their respective officers, employees and agents) adhere to the highest ethical standards, and report to the IIM Indore / Department all suspected acts of fraud or corruption or Coercion or Collusion of which it has knowledge or becomes aware, during the tendering process and throughout the negotiation or award of a contract.

(2) The Bidder(s)/Contractor(s) commits himself to take all measures necessary to prevent corruption. He commits himself to observe the following principles during his participation in the Tender process and during the Contract execution:

(a) The Bidder(s)/Contractor(s) will not, directly or through any other person or firm, offer, promise or give to any of the Principal/Owner's employees involved in the Tender process or execution of the Contract or to any third person any material or other benefit which he/she is not legally entitled to, in order to obtain in exchange any advantage of any kind whatsoever during the Tender process or during the execution of the Contract.

(b) The Bidder(s)/Contractor(s) will not enter with other Bidder(s) into any undisclosed agreement or understanding, whether formal or informal. This applies in particular to prices, specifications, certifications, subsidiary contracts, submission or non-submission of bids or any other actions to restrict competitiveness or to cartelize in the bidding process.

(c) The Bidder(s)/Contractor(s) will not commit any offence under the relevant IPC/PC Act. Further the Bidder(s)/Contractor(s) will not use improperly, (for the purpose of competition or personal gain), or pass on to others, any information or documents provided by the Principal/Owner as part of the business relationship, regarding plans, technical proposals and business details, including information contained or transmitted electronically. (d) The Bidder(s)/Contractor(s) of foreign origin shall disclose the names and addresses of agents/ representatives in India, if any. Similarly

Bidder(s)/Contractor(s) of Indian Nationality shall disclose names and addresses of foreign agents/representatives, if any. Either the Indian agent on behalf of the foreign principal or the foreign principal directly could bid in a tender but not both. Further, in cases where an agent participate in a tender on behalf of one manufacturer, he shall not be allowed to quote on behalf of another manufacturer along with the first manufacturer in a subsequent/parallel tender for the same item.

(d) The Bidder(s)/Contractor(s) will, when presenting his bid, disclose any and all payments he has made, is committed to or intends to make to agents, brokers or any other intermediaries in connection with the award of the Contract.

(3) The Bidder(s)/Contractor(s) will not instigate third persons to commit offences outlined above or be an accessory to such offences.

(4) The Bidder(s)/Contractor(s) will not, directly or through any other person or firm indulge in fraudulent practice means a willful misrepresentation or omission of facts or submission of fake/forged documents in order to induce public official to act in reliance thereof, with the purpose of obtaining unjust advantage by or causing damage to justified interest of others and/or to influence the procurement process to the detriment of the IIM Indore interests.

(5) The Bidder(s)/Contractor(s) will not, directly or through any other person or firm use Coercive Practices (means the act of obtaining something, compelling an action or influencing a decision through intimidation, threat or the use of force directly or indirectly, where potential or actual injury may befall upon a person, his/her reputation or property to influence their participation in the tendering process).

Article 3: Consequences of Breach

Without prejudice to any rights that may be available to the Principal/Owner under law or the Contract or its established policies and laid down procedures, the Principal/Owner shall have the following rights in case of breach of this Integrity Pact by the Bidder(s)/Contractor(s) and the Bidder/ Contractor accepts and undertakes to respect and uphold the Principal/Owner's absolute right:

(1) If the Bidder(s)/Contractor(s), either before award or during execution of Contract has committed a transgression through a violation of Article 2 above or in any other form, such as to put his reliability or credibility in question, the Principal/Owner after giving 14 days notice to the contractor shall have powers to disqualify the Bidder(s)/Contractor(s) from the Tender process or terminate/determine the Contract, if already executed or exclude the Bidder/Contractor from future contract award processes. The imposition and duration of the exclusion will be determined by the severity of transgression and determined by the Principal/Owner. Such exclusion may be forever or for a limited period as decided by the Principal/Owner.

(2) Forfeiture of EMD/Performance Guarantee/Security Deposit: If the Principal/Owner has disqualified the Bidder(s) from the Tender process prior to the award of the Contract or terminated/determined the Contract or has accrued the right

to terminate/determine the Contract according to Article 3(1), the Principal/Owner apart from exercising any legal rights that may have accrued to the Principal/Owner, may in its considered opinion forfeit the entire amount of Earnest Money Deposit, Performance Guarantee and Security Deposit of the Bidder/Contractor.

(3) Criminal Liability: If the Principal/Owner obtains knowledge of conduct of a Bidder or Contractor, or of an employee or a representative or an associate of a Bidder or Contractor which constitutes corruption within the meaning of IPC Act, or if the Principal/Owner has substantive suspicion in this regard, the Principal/Owner will inform the same to law enforcing agencies for further investigation.

Article 4: Previous Transgression

(1) The Bidder declares that no previous transgressions occurred in the last 5 years with any other Company in any country confirming to the anticorruption approach or with Central Government or State Government or any other Central/State Public Sector Enterprises in India that could justify his exclusion from the Tender process.

(2) If the Bidder makes incorrect statement on this subject, he can be disqualified from the Tender process or action can be taken for banning of business dealings/holiday listing of the Bidder/Contractor as deemed fit by the Principal/ Owner.

(3) If the Bidder/Contractor can prove that he has resorted / recouped the damage caused by him and has installed a suitable corruption prevention system, the Principal/Owner may, at its own discretion, revoke the exclusion prematurely.

Article 5: Equal Treatment of all Bidders/Contractors/Subcontractors

(1) The Bidder(s)/Contractor(s) undertake(s) to demand from all subcontractors a commitment in conformity with this Integrity Pact. The Bidder/Contractor shall be responsible for any violation(s) of the principles laid down in this agreement/Pact by any of its Subcontractors/sub-vendors.

(2) The Principal/Owner will enter into Pacts on identical terms as this one with all Bidders and Contractors.

(3) The Principal/Owner will disqualify Bidders, who do not submit, the duly signed Pact between the Principal/ Owner and the bidder, along with the Tender or violate its provisions at any stage of the Tender process, from the Tender process.

Article 6- Duration of the Pact

This Pact begins when both the parties have legally signed it. It expires for the Contractor/Vendor 12 months after the completion of work under the contract or till the continuation of defect liability period, whichever is more and for all other bidders, till the Contract has been awarded. If any claim is made/lodged during the time, the same shall be binding and continue to be valid despite the lapse of this Pacts as specified above, unless it is discharged/determined by the Competent Authority, IIM Indore.

Article 7- Other Provisions

(1) This Pact is subject to Indian Law, place of performance and jurisdiction is the Headquarters of the Division of the Principal/Owner, who has floated the Tender.

(2) Changes and supplements need to be made in writing. Side agreements have not been made.

(3) If the Contractor is a partnership or a consortium, this Pact must be signed by all the partners or by one or more partner holding power of attorney signed by all partners and consortium members. In case of a Company, the Pact must be signed by a representative duly authorized by board resolution.

(4) Should one or several provisions of this Pact turn out to be invalid; the remainder of this Pact remains valid. In this case, the parties will strive to come to an agreement to their original intensions.

(5) It is agreed term and condition that any dispute or difference arising between the parties with regard to the terms of this Integrity Agreement / Pact, any action taken by the Owner/Principal in accordance with this Integrity Agreement/ Pact or interpretation thereof shall not be subject to arbitration.

Article 8- LEGAL AND PRIOR RIGHTS

All rights and remedies of the parties hereto shall be in addition to all the other legal rights and remedies belonging to such parties under the Contract and/or law and the same shall be deemed to be cumulative and not alternative to such legal rights and remedies aforesaid. For the sake of brevity, both the Parties agree that this Integrity Pact will have precedence over the Tender/Contact documents with regard any of the provisions covered under this Integrity Pact.

IN WITNESS WHEREOF the parties have signed and executed this Integrity Pact at the place and date first above mentioned in the presence of following witnesses:

.....
(For and on behalf of Principal/Owner)

.....
(For and on behalf of Bidder/Contractor)

WITNESSES:

1.....
(Signature, name and address)

2.....
(Signature, name and address)

Place:

Dated:

L. Agreement

Format for Agreement

THIS AGREEMENT made at Indore on the ____ day of ____ 2022 between **Indian Institute of Management Indore Rau- Pithampur Road, Indore** (hereinafter called "**The IIM INDORE**" which expression shall, unless repugnant to the context or meaning thereof, include its administrators, successors and assigns) of the one part AND _____

(herein after called "**The Contractor**" which expression shall, unless repugnant to the context or meaning thereof, include its successors and permitted assigns) of the other part.

WHEREAS

The IIM INDORE is desirous of carrying out the work of "**Making, Supply & Installation of Furniture /Fixtures in Executive Residence-2 at IIM Indore**" issued vide NIT No.: IIMI/Project/07/2022/129 File No. 474

The Works are to be executed as per the scope of work, technical specifications, drawings etc. as is mentioned in the tender document for tendered rate amounting to Rs. _____.

The Contractor has agreed to execute the said works subject to the provisions hereinafter contained and subject also to General Conditions of Contract, Special conditions of contract, Safety Code, Model Rules for the protection of health and other arrangements for workers, Specifications, Preambles and Schedule of Quantities and erection & furnishing schedule (all of which are hereinafter collectively referred to as the 'said tender conditions') and strictly in accordance with the Scope of work annexed hereto at or for the respective rates set out in the Schedule of Quantities amounting to the sum as there under arrived at or such other sums as shall become payable there under (hereinafter referred to as the said tendered amount).

NOW IT IS HEREBY AGREED AS FOLLOWS: -

1. In consideration of the said tendered amount to be paid by The IIM INDORE to the Contractor at the time and in the manner set forth in the said tender conditions and in accordance with the Schedule of Payments to execute and complete the work shown upon the said Drawings strictly in accordance with the specifications and Schedule of Quantities.
2. The said tender conditions, scope of work and the annexure-1 hereto shall be read and considered as forming part of this contract and the parties hereto

shall respectfully abide by to the said conditions and perform the agreement on their part respectively contained in the said conditions.

3. The approved drawings if any, notice inviting tenders technical specification etc. shall also form the basis of this contract.
4. This contract is neither a Lump sum Contract, nor a piece work contract, but is a contract on item rate basis to be carried out and to be paid for according to the Schedule of Payments at the rates contained in the Schedule of Quantities.
5. The contract herein contained shall comprise not only the works mentioned above but all subsidiary works connected therewith within the same site as may be ordered to be done from time to time by the said Engineer-In-charge for the time being, even if such work may not be shown on the said Drawings or described in the said Specifications and Schedule of Quantities.
6. The IIM INDORE reserves to themselves the right of altering the drawings and the nature of the work by adding to or omitting from the scope of work any item of work or portions of the same without prejudice to this contract.
7. Time shall be considered as the essence of this contract and the Contractor hereby agrees to commence the work as mentioned in LOI/ work order and shall complete the entire work within the stipulated time limit.
8. All payments by the IIM INDORE under this contract shall be made only at Indore.
9. All disputes arising out of or in any way connected with this contract shall be deemed to have arisen in respect of IIM Indore and Director IIM Indore only shall have jurisdiction to determine the same.
10. That the contract and several parts of this contract have been read by the contractor and fully understood by him. The contractor shall not be entitled for payment beyond tendered quantities unless ordered specifically by written instructions of the Engineer-in-charge IIM INDORE.
11. This contract shall be signed in duplicate, the original whereof shall be kept in the custody of the IIM INDORE and the duplicate with the Contractor.
12. The Engineer-in-Charge may, without prejudice to his any other right or remedy against the contractor in respect of any delay, non-commencement, inferior workmanship, any claim for damages and/ or any other provisions of this contract or otherwise, and whether the date for completion has or has not elapsed, by notice in writing determine/ repudiate the contract.

IN WITNESS WHEREOF the IIM INDORE has set his hands hereunto and duplicate hereof through his duly authorized official and the Contractor has caused these presents and duplicate hereof under his common seal by his duly authorized representative at the place and on the date month and year first herein above written.

SIGNED, SEALED AND DELIVERED by IIM INDORE, by the hand of

Signature:

Name:

Designation:

IN THE PRESENCE OF

(1) Signature:

Name:

Address:

(2) Signature:

Name:

Address:

SIGNED, SEALED AND DELIVERED BY the Contractor **M/s** _____
_____.

Signature:

Name:

Designation:

IN THE PRESENCE OF

(1) Signature:

Name:

Address:

(2) Signature:

Name:

Address:

M. General Conditions of Contract

CLAUSES OF CONTRACT

CLAUSE 1

Performance Guarantee

- i. The contractor shall submit an irrevocable Performance Guarantee of 3% (Three percent) of the tendered amount in addition to other deposits mentioned elsewhere in the contract for his proper performance of the contract agreement, (not withstanding and/or without prejudice to any other provisions in the contract) within period specified in Schedule 'F' from the date of issue of letter of acceptance. This period can be further extended by the Engineer-in-Charge up to a maximum period as specified in schedule 'F' on written request of the contractor stating the reason for delays in procuring the Performance Guarantee, to the satisfaction of the Engineer-in-Charge. This guarantee shall be in the form of Cash (in case guarantee amount is less than Rs. 10,000/-) or Deposit at Call receipt of any scheduled bank/Banker's Cheque of any scheduled bank/Demand Draft of any scheduled bank/Pay Order of any scheduled bank (in case guarantee amount is less than Rs. 1,00,000/-) or Government Securities or Fixed Deposit Receipts or Guarantee Bonds of any Scheduled Bank or the State Bank of India in accordance with the form annexed hereto. In case a fixed deposit receipt of any Bank is furnished by the contractor to the IIM Indore as part of the performance guarantee and the Bank is unable to make payment against the said fixed deposit receipt, the loss caused thereby shall fall on the contractor and the contractor shall forthwith on demand furnish additional security to the IIM Indore to make good the deficit.
- ii. The Performance Guarantee shall be initially valid up to the stipulated date of completion plus minimum 60 days beyond that. If the same is submitted by the agency on schedule format I as per GCC. If the same is submitted on the format II as per GCC then the performance Guarantee shall be valid up to the stipulated date of completion plus minimum 6 months beyond that. In case the time for completion of work gets enlarged, the contractor shall get the validity of Performance Guarantee extended to cover such enlarged time for completion of work. After recording of the completion certificate for the work by the competent authority, the performance guarantee shall be returned to the contractor, without any interest. However, in case of contracts involving maintenance of building and services/any other work after construction of same building and services/other work, then 50% of Performance Guarantee shall be retained as Security Deposit. The same shall be returned year-wise proportionately.
- iii. The Engineer-in-Charge shall not make a claim under the performance guarantee except for amounts to which the Director IIM Indore is entitled under the contract (not withstanding and/or without prejudice to any other provisions in the contract agreement) in the event of:
 - a) Failure by the contractor to extend the validity of the Performance Guarantee as described herein above, in which event the Engineer-in-Charge may claim the full amount of the Performance Guarantee.

- b) Failure by the contractor to pay Director IIM Indore any amount due, either as agreed by the contractor or determined under any of the Clauses/Conditions of the agreement, within 30 days of the service of notice to this effect by Engineer-in-Charge.
- iv. In the event of the contract being determined or rescinded under provision of any of the Clause/Condition of the agreement, the performance guarantee shall stand forfeited in full and shall be absolutely at the disposal of the Director IIM Indore.

CLAUSE 1 A

Recovery of Security Deposit

The person/persons whose tender(s) may be accepted (hereinafter called the contractor) shall permit IIM Indore at the time of making any payment to him for work done under the contract to deduct a sum at the rate of 2.5% of the gross amount of each running and final bill till the sum deducted will amount to security deposit of 2.5% of the tendered value of the work. Such deductions will be made and held by IIM Indore by way of Security Deposit unless he/they has/have deposited the amount of Security at the rate mentioned above in cash or in the form of Government Securities or fixed deposit receipts. In case a fixed deposit receipt of any Bank is furnished by the contractor to the IIM Indore as part of the security deposit and the Bank is unable to make payment against the said fixed deposit receipt, the loss caused thereby shall fall on the contractor and the contractor shall forthwith on demand furnish additional security to the IIM Indore to make good the deficit.

All compensations or the other sums of money payable by the contractor under the terms of this contract may be deducted from, or paid by the sale of a sufficient part of his security deposit or from the interest arising therefrom, or from any sums which may be due to or may become due to the contractor by IIM Indore on any account whatsoever and in the event of his Security Deposit being reduced by reason of any such deductions or sale as aforesaid, the contractor shall within 10 days make good in cash or fixed deposit receipt tendered by the State Bank of India or by scheduled public sector banks or Government Securities (if deposited for more than 12 months) endorsed in favour of the competent authority, any sum or sums which may have been deducted from, or raised by sale of his security deposit or any part thereof. The security deposit shall be collected from the running bills and the final bill of the contractor at the rates mentioned above.

The security deposit as deducted above can be released against bank guarantee issued by a scheduled bank, on its accumulations to a minimum of Rs. 5 lac subject to the condition that amount of such bank guarantee, except last one, shall not be less than Rs. 5 lac. Provided further that the validity of bank guarantee including the one given against the earnest money shall be in conformity with provisions contained in clause 17 which shall be extended from time to time depending upon extension of contract granted under provisions of clause 2 and clause 5.

In case of contracts involving maintenance of building and services/any other work after construction of same building and services/other work, then 50% of Performance

Guarantee shall be retained as Security Deposit. The same shall be returned year wise proportionately.

Note-1: Government papers tendered as security will be taken at 5% (five per cent) below its market price or at its face value, whichever is less. The market price of Government paper would be ascertained by the competent authority at the time of collection of interest and the amount of interest to the extent of deficiency in value of the government paper will be withheld if necessary.

Note-2: Government Securities will include all forms of Securities mentioned in Rule No. 274 of the G.F. Rules except fidelity bond. This will be subject to the observance of the condition mentioned under the rule against each form of security.

Note-3: Note 1 & 2 above shall be applicable for both clause 1 and 1A

CLAUSE 2

Compensation for Delay

If the contractor fails to maintain the required progress in terms of clause 5 or to complete the work and clear the site on or before the contract or justified extended date of completion, as per clause 5 (excluding any extension under clause 5.5) as well as any extension granted under clauses 12 and 15, he shall, without prejudice to any other right or remedy available under the law to the IIM Indore on account of such breach, pay as agreed compensation the amount calculated at the rates stipulated below as the authority specified in schedule 'F' may decide on the amount of tendered value of the work for every completed day/month (as determined) that the progress remains below that specified in Clause 5 or that the work remains incomplete.

This will also apply to items or group of items for which a separate period of completion has been specified.

- i) Compensation for delay of work @ 2.0 % per week of delay to be computed on per day basis

Provided always that the total amount of compensation for delay to be paid under this Condition shall not exceed 10% of the Tendered Value of work or of the Tendered Value of the Sectional part of work as mentioned in Schedule 'F' for which a separate period of completion is originally given.

In case no compensation has been decided by the authority in Schedule 'F' during the progress of work, this shall be no waiver of right to levy compensation by the said authority if the work remains incomplete on final justified extended date of completion. If the Engineer in Charge decides to give further extension of time allowing performance of work beyond the justified extended date, the contractor shall be liable to pay compensation for such extended period. If any variation in amount of contract takes place during such extended period beyond justified extended date and the contractor becomes entitled to additional time under clause 12, the net period for such variation shall be accounted for while deciding the period for levy of compensation. However, during such further extended period beyond the justified

extended period, if any delay occurs by events under sub clause 5.2, the contractor shall be liable to pay compensation for such delay.

Provided that compensation during the progress of work before the justified extended date of completion for delay under this clause shall be for non-achievement of sectional completion or part handing over of work on stipulated/justified extended date for such part work or if delay affects any other works/services. This is without prejudice to right of action by the Engineer in Charge under clause 3 for delay in performance and claim of compensation under that clause.

In case action under clause 2 has not been finalized and the work has been determined under clause 3, the right of action under this clause shall remain post determination of contract but levy of compensation shall be for days the progress is behind the schedule on date of determination, as assessed by the authority in Schedule F, after due consideration of justified extension. The compensation for delay, if not decided before the determination of contract, shall be decided after of determination of contract.

The amount of compensation may be adjusted or set-off against any sum payable to the Contractor under this or any other contract with the IIM Indore. In case, the contractor does not achieve a particular milestone mentioned in schedule F, or the re-scheduled milestone(s) in terms of Clause 5.4, the amount shown against that milestone shall be withheld, to be adjusted against the compensation levied as above. With-holding of this amount on failure to achieve a milestone, shall be automatic without any notice to the contractor. However, if the contractor catches up with the progress of work on the subsequent milestone(s), the withheld amount shall be released. In case the contractor fails to make up for the delay in subsequent milestone(s), amount mentioned against each milestone missed subsequently also shall be withheld. However, no interest, whatsoever, shall be payable on such withheld amount.

CLAUSE 2A

Deleted

CLAUSE 3

When Contract can be Determined

Subject to other provisions contained in this clause, the Engineer-in-Charge may, without prejudice to his any other rights or remedy against the contractor in respect of any delay, inferior workmanship, any claims for damages and/or any other provisions of this contract or otherwise, and whether the date of completion has or has not elapsed, by notice in writing absolutely determine the contract in any of the following cases:

- i) If the contractor having been given by the Engineer-in-Charge a notice in writing to rectify, reconstruct or replace any defective work or that the work is being performed in an inefficient or otherwise improper or un-workman like manner shall omit to comply with the requirement of such notice for a period of seven days thereafter.

- ii) If the contractor has, without reasonable cause, suspended the progress of the work or has failed to proceed with the work with due diligence and continues to do so after a notice in writing of seven days from the Engineer-in-Charge.
- iii) If the contractor fails to complete the work or section of work with individual date of completion on or before the stipulated or justified extended date, on or before such date of completion; and the Engineer in Charge without any prejudice to any other right or remedy under any other provision in the contract has given further reasonable time in a notice given in writing in that behalf as either mutually agreed or in absence of such mutual agreement by his own assessment making such time essence of contract and in the opinion of Engineer-in-Charge the contractor will be unable to complete the same or does not complete the same within the period specified.
- iv) If the contractor persistently neglects to carry out his obligations under the contract and/ or commits default in complying with any of the terms and conditions of the contract and does not remedy it or take effective steps to remedy it within 7 days after a notice in writing is given to him in that behalf by the Engineer-in-Charge.
- v) If the contractor shall offer or give or agree to give to any person in IIM Indore service or to any other person on his behalf any gift or consideration of any kind as an inducement or reward for doing or forbearing to do or for having done or forborne to do any act in relation to the obtaining or execution of this or any other contract for IIM Indore.
- vi) If the contractor shall enter into a contract with IIM Indore in connection with which commission has been paid or agreed to be paid by him or to his knowledge, unless the particulars of any such commission and the terms of payment thereof have been previously disclosed in writing to the Engineer-in-Charge.
- vii) If the contractor had secured the contract with IIM Indore as a result of wrong tendering or other non-bonafide methods of competitive tendering or commits breach of Integrity Agreement.
- viii) If the contractor being an individual, or if a firm, any partner thereof shall at any time be adjudged insolvent or have a receiving order or order for administration of his estate made against him or shall take any proceedings for liquidation or composition (other than a voluntary liquidation for the purpose of amalgamation or reconstruction) under any Insolvency Act for the time being in force or make any conveyance or assignment of his effects or composition or arrangement for the benefit of his creditors or purport so to do, or if any application be made under any Insolvency Act for the time being in force for the sequestration of his estate or if a trust deed be executed by him for benefit of his creditors.
- ix) If the contractor being a company shall pass a resolution or the court shall make an order that the company shall be wound up or if a receiver or a manager on behalf of a creditor shall be appointed or if circumstances shall arise which entitle the court or the creditor to appoint a receiver or a manager or which entitle the court to make a winding up order.
- x) If the contractor shall suffer an execution being levied on his goods and allow it to be continued for a period of 21 days.

- xi) If the contractor assigns, (excluding part(s) of work assigned to other agency(s) by the contractor as per terms of contract), transfers, sublets (engagement of labour on a piece-work basis or of labour with materials not to be incorporated in the work, shall not be deemed to be subletting) or otherwise parts with or attempts to assign, transfer, sublet or otherwise parts with the entire works or any portion thereof without the prior written approval of the Engineer -in-Charge. When the contractor has made himself liable for action under any of the cases aforesaid, the Engineer-in-Charge on behalf of the Director, IIM Indore shall have powers:
- xii) (a) To determine the contract as aforesaid so far as performance of work by the Contractor is concerned (of which termination notice in writing to the contractor under the hand of the Engineer-in-Charge shall be conclusive evidence). Upon such determination, the Earnest Money Deposit, Security Deposit already recovered and Performance Guarantee under the contract shall be liable to be forfeited and shall be absolutely at the disposal of the IIM Indore.
- (b) After giving notice to the contractor to measure up the work of the contractor and to take such whole, or the balance or part thereof, as shall be un-executed out of his hands and to give it to another contractor to complete the work. The contractor, whose contract is determined as above, shall not be allowed to participate in the tendering process for the balance work. In the event of above courses being adopted by the Engineer-in-Charge, the contractor shall have no claim to compensation for any loss sustained by him by reasons of his having purchased or procured any materials or entered into any engagements or made any advances on account or with a view to the execution of the work or the performance of the contract. And in case action is taken under any of the provision aforesaid, the contractor shall not be entitled to recover or be paid any sum for any work thereof or actually performed under this contract unless and until the Engineer-in-Charge has certified in writing the performance of such work and the value payable in respect thereof and he shall only be entitled to be paid the value so certified.

CLAUSE 3A

In case, the work cannot be started due to reasons not within the control of the contractor within 1/8th of the stipulated time for completion of work or one month whichever is higher, either party may close the contract by giving notice to the other party stating the reasons. In such eventuality, the Performance Guarantee of the contractor shall be refunded within 15 days neither party shall claim any compensation for such eventuality. This clause is not applicable for any breach of the contract by either party.

CLAUSE 4

Contractor liable to pay Compensation even if action not taken under Clause 3

In any case in which any of the powers conferred upon the Engineer-in-Charge by Clause-3 thereof, shall have become exercisable and the same are not exercised, the non-exercise thereof shall not constitute a waiver of any of the conditions hereof and such powers shall notwithstanding be exercisable in the event of any future case of default by the contractor and the liability of the contractor for compensation shall remain unaffected. In the event of the Engineer-in-Charge putting in force all or any

of the powers vested in him under the preceding clause he may, if he so desires after giving a notice in writing to the contractor, take possession of (or at the sole discretion of the Engineer-in-Charge which shall be final and binding on the contractor) use as on hire (the amount of the hire money being also in the final determination of the Engineer-in-Charge) all or any tools, plant, materials and stores, in or upon the works, or the site thereof belonging to the contractor, or procured by the contractor and intended to be used for the execution of the work/or any part thereof, paying or allowing for the same in account at the contract rates, or, in the case of these not being applicable, at current market rates to be certified by the Engineer-in-Charge, whose certificate thereof shall be final, and binding on the contractor, clerk of the works, foreman or other authorized agent to remove such tools, plant, materials, or stores from the premises (within a time to be specified in such notice) in the event of the contractor failing to comply with any such requisition, the Engineer-in-Charge may remove them at the contractor's expense or sell them by auction or private sale on account of the contractor and his risk in all respects and the certificate of the Engineer-in-Charge as to the expenses of any such removal and the amount of the proceeds and expenses of any such sale shall be final and conclusive against the contractor.

CLAUSE 5

Time and Extension for Delay

The time allowed for execution of the Works as specified in the Schedule 'F' or the extended time in accordance with these conditions shall be the essence of the Contract. The execution of the work shall commence from such time period as mentioned in schedule 'F' or from the date of handing over of the site, notified by the Engineer-in-Charge, whichever is later. If the Contractor commits default in commencing the execution of the work as aforesaid, the performance guarantee shall be forfeited by the Engineer in Charge and shall be absolutely at the disposal of the IIM Indore without prejudice to any other right or remedy available in law.

5.1

i. As soon as possible but within 7 (seven) working days of award of work and in consideration of

a) Schedule of handing over of site as specified in the Schedule 'F'

b) Schedule of issue of drawings if applicable as specified in the Schedule 'F'

The Contractor shall submit a Time and Progress Chart for each mile stone. The Engineer-in-Charge may within 7 (seven) working days thereafter, if required modify, and communicate the program approved to the contractor failing which the program submitted by the contractor shall be deemed to be approved by the Engineer-in-Charge. The work programme shall include all details of balance drawings and decisions required to complete the contract with specific dates by which these details are required by contractor without causing any delay in execution of the work. The Chart shall be prepared in direct relation to the time stated in the Contract documents for completion of items of the works. It shall indicate the forecast of the dates of commencement and completion of various trades of sections of the work and may be amended as necessary by agreement between the Engineer-in-Charge and the Contractor within the limitations of time imposed in the Contract documents.

- ii. In case of non-submission of work programme by the contractor the program approved by the Engineer-in-Charge shall be deemed to be final.
- iii. The approval by the Engineer-in-Charge of such programme shall not relieve the contractor of any of the obligations under the contract.
- iv. The contractor shall submit the Time and Progress Chart and progress report using the mutually agreed software or in other format decided by Engineer-in-Charge for the work done during previous month to the Engineer-in-charge on or before 5th day of each month failing which a recovery as per Schedule F to be decided by the NIT approving authority shall be made on per week or part basis in case of delay in submission of the monthly progress report.

5.2

If the work(s) be delayed by:-

- i. Force majeure, or
- ii. Abnormally bad weather, or
- iii. Serious loss or damage by fire, or
- iv. Civil commotion, local commotion of workmen, strike or lockout, affecting any of the trades employed on the work, or
- v. Delay on the part of other contractors or tradesmen engaged by engineer-in-charge in executing work not forming part of the contract, or
- vi. Non-availability of stores, which are the responsibility of IIM Indore to supply or
- vii. Non-availability or break down of tools and plant to be supplied or supplied by IIM Indore or
- viii. Any other cause like above which, in the reasoned opinion of the engineer-in-charge is beyond the contractor's control.

then upon the happening of any such event causing delay, the Contractor shall immediately give notice thereof in writing to the Engineer-in-Charge for entry in the hindrance register (physical or web-based as prescribed in Schedule 'F' but shall nevertheless use constantly his best endeavours to prevent or make good the delay and shall do all that may be reasonably required to the satisfaction of the Engineer-in-Charge to proceed with the works.

The contractor shall have no claim of damages for extension of time granted or rescheduling of milestone/s for events listed in sub clause 5.2.

5.3

In case the work is hindered in the opinion of the contractor, by the Department for any reason/event, for which the Department is responsible, the contractor The authority as indicated in Schedule 'F' shall, if justified, give a fair and reasonable extension of time and reschedule the mile stones for completion of work Such extension of time or rescheduling of milestone/s shall be without prejudice to any other right or remedy of the parties in contract or in law; provided further that for concurrent delays under this sub clause and sub clause 5.2 to the extent the delay is covered under sub clause 5.2 the contractor shall be entitled to only extension of time and no damages.

5.4

Request for rescheduling of Mile stones or extension of time, to be eligible for consideration, shall be made by the Contractor in writing within fourteen days of the happening of the event causing delay on the prescribed forms i.e. Form of application by the contractor for seeking rescheduling of milestones (Appendix-XVI) or Form of application by the contractor for seeking extension of time (Appendix -XVII) respectively to the authority as indicated in Schedule 'F'. The Contractor shall indicate in such a request the period by which rescheduling of milestone/s or extension of time is desired.

With every request for rescheduling of milestones, or if at any time the actual progress of work falls behind the approved programme by more than 10% of the stipulated period of completion of contract, the contractor shall produce a revised programme which shall include all details of pending drawings and decisions required to complete the contract and also the target dates by which these details should be available without causing any delay in execution of the work. A recovery as specified in Schedule 'F' shall be made on per day basis in case of delay in submission of the revised programme.

5.4.1

In any such case the authority as indicated in Schedule 'F' may give a fair and reasonable extension of time for completion of work or reschedule the mile stones. Engineer -in-Charge shall finalize/ reschedule a particular mile stone before taking an action against subsequent mile stone. Such extension or rescheduling of the milestones shall be communicated to the Contractor by the authority as indicated in Schedule 'F' in writing, within 21 days of the date of receipt of such request from the Contractor in prescribed form. In event of non-application by the contractor for extension of time E-in-C after affording opportunity to the contractor, may give, supported with a programme (as specified under 5.4 above), a fair and reasonable extension within a reasonable period of occurrence of the event.

5.5

In case the work is delayed by any reasons, in the opinion of the Engineer-in-Charge, by the contractor for reasons beyond the events mentioned in clause 5.2 or clause 5.3 or clause 5.4 and beyond the justified extended date; without prejudice to right to take action under Clause 3, the Engineer-in-Charge may grant extension of time required for completion of work without rescheduling of milestones. The contractor shall be liable for levy of compensation for delay for such extension of time.

CLAUSE 5 A

Time is the essence of the contract for Maintenance Works estimated cost upto Rs. 25 Lacs (Modified OM No. DG/CON/307 dt. 19.11.2019)

The time allowed for execution of the work as specified in the Schedule 'F' shall be the essence of the Contract i.e. the contract period will not be extended. The execution of the work shall commence from such time period as mentioned in schedule 'F'. If the contractor commits default in commencing the execution of the work as aforesaid the performance guarantee shall be forfeited by the Engineer in Charge and shall be absolutely at the disposal of the IIM Indore without prejudice to any other right or remedy available in law.

CLAUSE 6

Computerized Measurement Book

Engineer-in-Charge shall, except as otherwise provided, ascertain and determine by measurement the value of work done in accordance with the contract.

All measurements of all items having financial value shall be entered by the contractor and compiled in the shape of the Computerized Measurement Book having pages of A-4 size as per the format of the department so that a complete record is obtained of all the items of works performed under the contract.

All such measurements and levels recorded by the contractor or his authorized representative from time to time, during the progress of the work, shall be got checked by the contractor from the Engineer-in-Charge or his authorized representative as per interval or program fixed in consultation with Engineer-in-Charge or his authorized representative. After the necessary corrections made by the Engineer-in-Charge, the measurement sheets shall be returned to the contractor for incorporating the corrections and for resubmission to the Engineer-in-Charge for the dated signatures by the Engineer-in-Charge and the contractor or their representatives in token of their acceptance.

Whenever bill is due for payment, the contractor would initially submit draft computerized measurement sheets and these measurements would be got checked/test checked from the Engineer-in-Charge and/or his authorized representative. The contractor will, thereafter, incorporate such changes as may be done during these checks/test checks in his draft computerized measurements, and submit to the department a computerized measurement book, duly bound, and with its pages machine numbered. The Engineer-in-Charge and/or his authorized representative would thereafter check this MB, and record the necessary certificates for their checks/test checks.

The final, fair, computerized measurement book given by the contractor, duly bound, with its pages machine numbered, should be 100% correct, and no cutting or overwriting in the measurements would thereafter be allowed. If at all any error is noticed, the contractor shall have to submit a fresh computerized MB with its pages duly machine numbered and bound, after getting the earlier MB cancelled by the department. Thereafter, the MB shall be taken in the department records, and allotted a number as per the Register of Computerized MBs. This should be done before the corresponding bill is submitted to the Department for payment. The contractor shall submit two spare copies of such computerized MB's for the purpose of reference and record by the various officers of the department.

The contractor shall also submit to the department separately his computerized Abstract of Cost and the bill based on these measurements, duly bound, and its pages machine numbered along with two spare copies of the "bill. Thereafter, this bill will be processed by the Department and allotted a number as per the computerized record in the same way as done for the measurement book meant for measurements.

The contractor shall, without extra charge, provide all assistance with every appliance, labour and other things necessary for checking of measurements/levels by the Engineer-in- Charge or his representative.

Except where any general or detailed description of the work expressly shows to the contrary, measurements shall be taken in accordance with the procedure set forth in the specifications notwithstanding any provision in the relevant Standard Method of measurement or any general or local custom. In the case of items which are not covered by specifications, measurements shall be taken in accordance with the relevant standard method of measurement issued by the Bureau of Indian Standards and if for any item no such standard is available then a mutually agreed method shall be followed.

The contractor shall give not less than seven days' notice to the Engineer-in-Charge or his authorized representative in charge of the work before covering up or otherwise placing beyond the reach of checking and/or test checking the measurement of any work in order that the same may be checked and/or test checked and correct dimensions thereof be taken before the same is covered up or placed beyond the reach of checking and/or test checking measurement and shall not cover up and place beyond reach of measurement any work without consent in writing of the Engineer-in-Charge or his authorized representative in charge of the work who shall within the aforesaid period of seven days inspect the work, and if any work shall be covered up or placed beyond the reach of Checking and/or test checking measurements without such notice having been given or the Engineer-in-Charge's consent being obtained in writing the same shall be uncovered at the Contractor's expense, or in default thereof no payment or allowance shall be made for such work or the materials with which the same was executed.

Engineer-in-Charge or his authorized representative may cause either themselves or through another officer of the department to check the measurements recorded by contractor and all provisions stipulated herein above shall be applicable to such checking of measurements or levels.

It is also a term of this contract that checking and/or test checking the measurements of any item of work in the measurement book and/or its payment in the interim, on account of final bill shall not be considered as conclusive evidence as to the sufficiency of any work or material to which it relates nor shall it relieve the contractor from liabilities from any over measurement or defects noticed till completion of the defects liability period.

CLAUSE 7

Payment of Intermediate Certificate to be regarded as Advances

No payment shall be made for work, estimated to cost Rs. two lac or less till after the whole of the work shall have been completed and certificate of completion given. For works estimated to cost over Rs. Two lac, the interim or running account bills shall be submitted by the contractor for the work executed on the basis of such recorded measurements on the format of the Department in triplicate on or before the date of every month fixed for the same by the Engineer-in-Charge. The contractor shall not

be entitled to be paid any such interim payment if the gross work done together with net payment/ adjustment of advances for material collected, if any, since the last such payment is less than the amount specified in Schedule 'F', in which case the interim bill shall be prepared on the appointed date of the month after the requisite progress is achieved. Engineer-in-Charge shall arrange to have the bill verified by taking or causing to be taken, where necessary, the requisite measurements of the work. In the event of the failure of the contractor to submit the bills, no claims whatsoever due to delays on payment including that of interest shall be payable to the contractor. Payment on account of amount admissible shall be made by the Engineer-in-Charge certifying the sum to which the contractor is considered entitled by way of interim payment at such rates as decided by the Engineer-in-Charge. The amount admissible shall be paid by 10th working day after the day of presentation of the bill by the Contractor to the Engineer-in-Charge or his Asstt. Engineer together with the account of the material issued by the department, or dismantled materials, if any. In the case of works outside the headquarters of the Engineer- in-Charge, the period of ten working days will be extended to fifteen working days. All such interim payments shall be regarded as payment by way of advances against final payment only and shall not preclude the requiring of bad, unsound and imperfect or unskilled work to be rejected, removed, taken away and reconstructed or re-erected. Any certificate given by the Engineer-in-Charge relating to the work done or materials delivered forming part of such payment, may be modified or corrected by any subsequent such certificate(s) or by the final certificate and shall not by itself be conclusive evidence that any work or materials to which it relates is/are in accordance with the contract and specifications. Any such interim payment, or any part thereof shall not in any respect conclude, determine or affect in any way powers of the Engineer-in-Charge under the contract or any of such payments be treated as final settlement and adjustment of accounts or in any way vary or affect the contract.

Pending consideration of extension of date of completion, interim payments shall continue to be made as herein provided without prejudice to the right of the department to take action under the terms of this contract for delay in the completion of work, if the extension of date of completion is not granted by the competent authority.

The Engineer-in-Charge in his sole discretion on the basis of a certificate from the Asstt. Engineer to the effect that the work has been completed up to the level in question make interim advance payments without detailed measurements for work done (other than foundations, items to be covered under finishing items) up to lintel level (including sunshade etc.) and slab level, for each floor working out at 75% of the assessed value. The advance payments so allowed shall be adjusted in the subsequent interim bills to be submitted by the contractor within 10 days of the interim payment. In case of delay in submission of bill by the contractor a simple interest @ 10% (ten percent) per annum shall be paid to the IIM Indore from the date of expiry of prescribed time limit which will be compounded on yearly basis.

Payments in composite Contracts

In case of composite tenders, running payment for the major component shall be made by EE of major discipline to the main contractor. Running payment for minor

component shall be made by the Engineer-in-Charge of the discipline of minor component directly to the main contractor.

CLAUSE 7A

No Running Account Bill shall be paid for the work till the applicable labour licenses, registration with EPFO, ESIC and BOCW Welfare Board, whatever applicable are submitted by the contractor to the Engineer-in-Charge.

CLAUSE 8

Completion Certificate

Within ten days of the completion of the work, the contractor shall give notice of such completion to the Engineer-in-Charge and within thirty days of the receipt of such notice, the Engineer-in-Charge shall inspect the work and if there is no defect in the work, shall furnish the contractor with a final certificate of completion, otherwise a provisional certificate of physical completion indicating defects (a) to be rectified by the contractor and/or (b) for which payment will be made at reduced rates, shall be issued. But no final certificate of completion shall be issued, nor shall the work be considered to be complete until the contractor shall have removed from the premises on which the work shall be executed all scaffolding, surplus materials, rubbish and all huts and sanitary arrangements required for his/their work people on the site in connection with the execution of the works as shall have been erected or constructed by the contractor(s) and cleaned off the dirt from all wood work, doors, windows, walls, floor or other parts of the building, in, upon, or about which the work is to be executed or of which he may have had possession for the purpose of the execution; thereof, and not until the work shall have been measured by the Engineer-in-Charge. If the contractor shall fail to comply with the requirements of this Clause as to removal of scaffolding, surplus materials and rubbish and all huts and sanitary arrangements as aforesaid and cleaning off dirt on or before the date fixed for the completion of work, the Engineer-in-Charge may at the expense of the contractor remove such scaffolding, surplus materials and rubbish etc., and dispose of the same as he thinks fit and clean off such dirt as aforesaid, and the contractor shall have no claim in respect of scaffolding or surplus materials as aforesaid except for any sum actually realized by the sale thereof.

CLAUSE 8A

Contractor to Keep Site Clean

When the annual repairs and maintenance of works are carried out, the splashes and droppings from white washing, colour washing, painting etc., on walls, floor, windows, etc. shall be removed and the surface cleaned simultaneously with the completion of these items of work in the individual rooms, quarters or premises etc. where the work is done: without waiting for the actual completion of all the other items of work in the contract. In case the contractor fails to comply with the requirements of this clause, the Engineer-in-Charge shall have the right to get this work done at the cost of the contractor either departmentally or through any other agency. Before taking such action, the Engineer-in-Charge shall give ten days' notice in writing to the contractor.

CLAUSE 9

Payment of Final Bill

The final bill shall be submitted by the contractor in the same manner as specified in interim bills within three months of physical completion of the work or within one month of the date of the final certificate of completion furnished recorded by the Engineer-in-Charge whichever is earlier. No further claims shall be made by the contractor after submission of the final bill and these shall be deemed to have been waived and extinguished. Payments of those items of the bill in respect of which there is no dispute and of items in dispute, for quantities and rates as approved by Engineer-in-Charge, will, as far as possible be made within three months the period specified here in under, the period being reckoned from the date of receipt of the bill by the Engineer-in- Charge or his authorized Asstt. Engineer/ Junior Engineer, complete with account of materials issued by the Department and dismantled materials if any.

- i. If the Tendered value of work is up to Rs. 45 lac : 2 months
- ii. If the Tendered value of work is more than Rs.45 lac and up to Rs. 2.5 Crore : 3 months
- iii. If the Tendered value of work exceeds Rs. 2.5 Crore : 6 months

If the final bill is submitted by the contractor within the period specified above and delay in payment of final bills is made by the deptt. After prescribed time limit a simple interest@ 5% per annum shall be paid to the contractor from the date of expiry of prescribed time limit which will be compounded on yearly basis, provided the final bill submitted by the contractor is found to be in order. If the contractor or his authorized representative does not remain present at the time of such measurement after the contractor or his authorized representative has been given a notice in writing three (3) days in advance or fails to countersign or to record objection within a week from the date of the measurement, then such measurement recorded in his absence by the Engineer-in- Charge or his representative shall be deemed to be accepted by the contractor. If for any reason the Contractor or his authorized representative is not available and the work of recording measurement is suspended by the Engineer- in - Charge or his representative, the Engineer- in - Charge and the Department shall not entertain any claim from contractor for any loss or damages on this account.

CLAUSE 9A

Payment of Contractor's Bills to Banks

Payments due to the contractor may, if so desired by him, be made to his bank, registered financial, co-operative or thrift societies or recognized financial institutions instead of direct to him provided that the contractor furnishes to the Engineer-in-Charge (1) an authorization in the form of a legally valid document such as a power of attorney conferring authority on the bank; registered financial, co-operative or thrift societies or recognized financial institutions to receive payments and (2) his own acceptance of the correctness of the amount made out as being due to him by IIM Indore or his signature on the bill or other claim preferred against IIM Indore before settlement by the Engineer-in-Charge of the account or claim by payment to the bank, registered financial, co-operative or thrift societies or recognized financial institutions. While the receipt given by such banks; registered financial, co-operative or thrift societies or recognized financial institutions shall constitute a full and sufficient discharge for the payment, the contractor shall

whenever possible present his bills duly receipted and discharged through his bank, registered financial, co-operative or thrift societies or recognized financial institutions.

Nothing herein contained shall operate to create in favour of the bank; registered financial, co-operative or thrift societies or recognized financial institutions any rights or equities vis-a-vis the Director, IIM Indore.

CLAUSE 10A

Materials to be provided by the Contractor

The contractor shall, at his own expense, provide all materials, required for the works other than those which are stipulated to be supplied by the IIM Indore.

The contractor shall, at his own expense and without delay, supply to the Engineer-in-Charge samples of materials to be used on the work and shall get these approved in advance. All such materials to be provided by the Contractor shall be in conformity with the specifications laid down or referred to in the contract. The contractor shall, if requested by the Engineer-in-Charge furnish proof, to the satisfaction of the Engineer-in-Charge that the materials so comply. The Engineer-in-Charge shall within thirty days of supply of samples or within such further period as he may require intimate to the Contractor in writing whether samples are approved by him or not. If samples are not approved, the Contractor shall forthwith arrange to supply to the Engineer-in-Charge for his approval, fresh samples complying with the specifications laid down in the contract. When materials are required to be tested in accordance with specifications, approval of the Engineer-in-Charge shall be issued after the test results are received.

The Contractor shall at his risk and cost submit the samples of materials to be tested or analyzed and shall not make use of or incorporate in the work any materials represented by the samples until the required tests or analysis have been made and materials finally accepted by the Engineer-in-Charge. The Contractor shall not be eligible for any claim or compensation either arising out of any delay in the work or due to any corrective measures required to be taken on account of and as a result of testing of materials.

The contractor shall, at his risk and cost, make all arrangements and shall provide all facilities as the Engineer-in-Charge may require for collecting, and preparing the required number of samples for such tests at such time and to such place or places as may be directed by the Engineer-in-Charge and bear all charges and cost of testing unless specifically provided for otherwise elsewhere in the contract or specifications. The Engineer-in-Charge or his authorized representative shall at all times have access to the works and to all workshops and places where work is being prepared or from where materials, manufactured articles or machinery are being obtained for the works and the contractor shall afford every facility and every assistance in obtaining the right to such access.

The Engineer-in-Charge shall have full powers to require the removal from the premises of all materials which in his opinion are not in accordance with the

specifications and in case of default, the Engineer-in-Charge shall be at liberty to employ at the expense of the contractor, other persons to remove the same without being answerable or accountable for any loss or damage that may happen or arise to such materials. The Engineer-in-Charge shall also have full powers to require other proper materials to be substituted thereof and in case of default, the Engineer-in-Charge may cause the same to be supplied and all costs which may attend such removal and substitution shall be borne by the Contractor.

The contractor shall at his own expense, provide a material testing lab at the site for conducting routine field tests. The lab shall be equipped at least with the testing equipment as specified in schedule F.

CLAUSE 10B

Secured Advance on Materials

The contractor, on signing an indenture in the form to be specified by the Engineer-in-Charge, shall be entitled to be paid during the progress of the execution of the work up to 75% of the assessed value of any materials or an amount not exceeding 75% of the material element cost in the tendered rate of the finished item of the work, whichever is lower, which are in the opinion of the Engineer-in-Charge non-perishable, nonfragile and non-combustible and are in accordance with the contract and which have been brought on the site in connection therewith and are adequately stored and/or protected against damage by weather or other causes but which have not at the time of advance been incorporated in the works. When materials on account of which an advance has been made under this sub-clause are incorporated in the work, the amount of such advance shall be recovered/deducted from the next payment made under any of the clause or clauses of this contract.

Such secured advance shall also be payable on other items of perishable nature, fragile and combustible with the approval of the Engineer-in-Charge provided the contractor provides a comprehensive insurance cover for the full cost of such materials. The decision of the Engineer-in-Charge shall be final and binding on the contractor in this matter. No secured advance, shall however, be paid on high-risk materials such as ordinary glass, sand, petrol, diesel etc.

No mobilisation advance shall be paid to the contractor.

CLAUSE 10C

Payment on Account of Increase in Prices/Wages due to Statutory Order(s) - Deleted.

CLAUSE 10 CC

Payment due to Increase/Decrease in Prices/Wages (excluding materials covered under clause 10 CA) after Receipt of Tender for Works - Deleted.

CLAUSE 10 D

Dismantled Material IIM Indore Property

The contractor shall treat all materials obtained during dismantling of a structure, excavation of the site for a work, etc. as IIM Indore's property and such materials shall

be disposed off to the best advantage of IIM Indore according to the instructions in writing issued by the Engineer-in-Charge.

CLAUSE 11

Work to be executed in Accordance with Specifications, Drawings, Orders etc.

The contractor shall execute the whole and every part of the work in the most substantial and workmanlike manner both as regards materials and otherwise in every respect in strict accordance with the specifications. The contractor shall also conform exactly, fully and faithfully to the design, drawings and instructions in writing in respect of the work signed by the Engineer-in-Charge and the contractor shall be furnished free of charge one copy of the contract documents together with specifications, designs, drawings and instructions as are not included in the standard specifications of Central Public Works Department specified in Schedule „F“ or in any Bureau of Indian Standard or any other, published standard or code or, Schedule of Rates or any other printed publication referred to elsewhere in the contract.

The contractor shall comply with the provisions of the contract and with the care and diligence execute and maintain the works and provide all labour and materials, tools and plants including for measurements and supervision of all works, structural plans and other things of temporary or permanent nature required for such execution and maintenance in so far as the necessity for providing these, is specified or is reasonably inferred from the contract. The Contractor shall take full responsibility for adequacy, suitability and safety of all the works and methods of construction.

CLAUSE 12:

Deviations/Variations Extent and Pricing

The Engineer-in-Charge shall have power:

- (i) to make alteration in, omissions from, additions to, or substitutions for the original specifications, drawings, designs and instructions that may appear to him to be necessary or advisable during the progress of the work, and
- (ii) to omit a part of the works in case of non-availability of a portion of the site or for any other reasons and the contractor shall be bound to carry out the works in accordance with any instructions given to him in writing signed by the Engineer-in-Charge and such alterations, omissions, additions or substitutions shall form part of the contract as if originally provided therein and any altered, additional or substituted work which the contractor may be directed to do in the manner specified above as part of the works, shall be carried out by the contractor on the same conditions in all respects including price on which he agreed to do the main work except as hereafter provided.

The completion cost of any agreement for Maintenance works including works of upgradation, aesthetic, special repair, addition/ alteration should not exceed 1.25 times of Tendered amount. Any further deviation beyond this limit upto 1.5 times of tendered amount shall be approved by the authority mentioned in schedule 'F' with recorded reason and in exceptional case, competent authority shall have full power to approve the deviation beyond 1.50 times of tendered amount with recorded reason and take suitable corrective action.

12.1

The time for completion of the works shall, in the event of any deviations resulting in additional cost over the tendered value sum being ordered, be extended, if requested by the contractor, as follows:

- i. In the proportion which the additional cost of the altered, additional or substituted work, bears to the original tendered value plus
- ii. 25% of the time calculated in (i) above or such further additional time as may be considered reasonable by the Engineer-in-Charge.

12.2

Deviation, Extra Items and Pricing

In the case of Extra(s) being the schedule items (Delhi Schedule of Rates items) items, these shall be paid as per the schedule rate plus cost index (at the time of tender) plus/minus percentage above/ below quoted contract amount. Payment of Extra items in case of non-schedule items (Non-DSR items) shall be made as per the prevailing market rate.

Deviation, deviated Quantities, Pricing

Deviation, Substituted Items In

In the case of Substitute Item(s) being the schedule items (Delhi Schedule of Rates items), these shall be paid as per the schedule rate plus cost index (at the time of tender) plus/minus percentage above/ below quoted contract amount. Payment of Substitute in case of non-schedule items (Non-DSR items) shall be made as per the prevailing market rate. In the case of contract items, which exceed the limits laid down in schedule F, the contractor shall be paid rates at Agreement rate/Market rate whichever is lower.

12.3

In case of decrease in the rates prevailing in the market of items for the work in excess of the limits laid down in Schedule F, the Engineer-in-Charge shall after giving notice to the contractor within one month of occurrence of the excess and after taking into consideration any reply received from him within fifteen days of the receipt of the notice, revise the rates for the work in question within one month of the expiry of the said period of fifteen days having regard to the market rates.

12.4

For the purpose of operation of Schedule "F", the following works shall be treated as works relating to foundation unless & otherwise defined in the contract:

- i. For Buildings: All works up to 1.2 metres above ground level or up to floor 1 level whichever is lower.
- ii. For abutments, piers and well staining: All works up to 1.2 m above the bed level.
- iii. For retaining walls, wing walls, compound walls, chimneys, overhead reservoirs/ tanks and other elevated structures: All works up to 1.2 metres above the ground level.

- iv. For reservoirs/tanks (other than overhead reservoirs/tanks): All works up to 1.2 metres above the ground level.
- v. For basement: All works up to 1.2 m above ground level or up to floor 1 level whichever is lower.
- vi. For Roads, all items of excavation and filling including treatment of sub base.

12.5

Any operation incidental to or necessarily has to be in contemplation of tenderer while quoting filing tender, or necessary for proper execution of the item included in the Schedule of quantities or in the schedule of rates mentioned above, whether or not, specifically indicated in the description of the item and the relevant specifications, shall be deemed to be included in the rates quoted by the tenderer or the rate given in the said schedule of rates, as the case may be. Nothing extra shall be admissible for such operations.

CLAUSE 13

Foreclosure of contract due to Abandonment or Reduction in Scope of Work

If at any time after acceptance of the tender or during the progress of work, the purpose or object for which the work is being done changes due to any supervening cause and as a result of which the work has to be abandoned or reduced in scope the Engineer-in-Charge shall give notice in writing to that effect to the contractor stating the decision as well as the cause for such decision and the contractor shall act accordingly in the matter. The contractor shall have no claim to any payment of compensation or otherwise whatsoever, on account of any profit or advantage which he might have derived from the execution of the works in full but which he did not derive in consequence of the foreclosure of the whole or part of the works.

The contractor shall be paid at contract rates, full amount for works executed at site and, in addition, a reasonable amount as certified by the Engineer-in-Charge for the items hereunder mentioned which could not be utilized on the work to the full extent in view of the foreclosure;

- i) Any expenditure incurred on preliminary site work, e.g. temporary access roads, temporary labour huts, staff quarters and site office; storage accommodation and water storage tanks.
- ii) IIM Indore shall have the option to take over contractor's materials or any part thereof either brought to site or of which the contractor is legally bound to accept delivery from suppliers (for incorporation in or incidental to the work) provided, however IIM Indore shall be bound to take over the materials or such portions thereof as the contractor does not desire to retain. For materials taken over or to be taken over by IIM Indore, cost of such materials as detailed by Engineer-in- Charge shall be paid. The cost shall, however, take into account purchase price, cost of transportation and deterioration or damage which may have been caused to materials whilst in the custody of the contractor. Reasonable compensation for transfer of T & P from site to contractor's permanent stores or to his other works,

whichever is less. If T & P are not transported to either of the said places, no cost of transportation shall be payable.

- iii) Reasonable compensation for repatriation of contractor's site staff and imported labour to the extent necessary.

The contractor shall, if required by the Engineer- in-Charge, furnish to him, books of account, wage books, time sheets and other relevant documents and evidence as may be necessary to enable him to certify the reasonable amount payable under this condition.

The reasonable amount of items on (i), (iv) and (v) above shall not be in excess of 2% of the cost of the work remaining incomplete on the date of closure, i.e. total stipulated cost of the work as per accepted tender less the cost of work actually executed under the contract and less the cost of contractor's materials at site taken over by the IIM Indore as per item (ii) above. Provided always that against any payments due to the contractor on this account or otherwise, the Engineer-in-Charge shall be entitled to recover or be credited with any outstanding balances due from the contractor for advance paid in respect of any tool, plants and materials and any other sums which at the date of termination were recoverable by the IIM Indore from the contractor under the terms of the contract.

In the event of action being taken under Clause 13 to reduce the scope of work, the contractor may furnish fresh Performance Guarantee on the same conditions, in the same manner and at the same rate for the balance tendered amount and initially valid up to the extended date of completion or stipulated date of completion if no extension has been granted plus 60 days beyond that. Wherever such a fresh Performance Guarantee is furnished by the contractor the Engineer-in-Charge may return the previous Performance Guarantee.

Clause 14

Carrying out part work at risk & cost of contractor

If contractor:

- i) At any time makes default during currency of work or does not execute any part of the work with due diligence and continues to do so even after a notice in writing of 7 days in this respect from the Engineer-in-Charge; or
- ii) Commits default in complying with any of the terms and conditions of the contract and does not remedy it or takes effective steps to remedy it within 7 days even after a notice in writing is given in that behalf by the Engineer-in-Charge; or

Fails to complete the work(s) or items of work with individual dates of completion, on or before the date(s) so determined, and does not complete them within the period specified in the notice given in writing in that behalf by the Engineer-in-Charge.

- iii) The Engineer- in-Charge without invoking action under clause 3 may, without prejudice to any other right or remedy against the contractor which

have either accrued or accrue thereafter to IIM Indore, by a notice in writing to take the part work / part incomplete work of any item(s) out of his hands and shall have powers to:

- a) Take possession of the site and any materials, constructional plant, implements, stores, etc., thereon; and/or
- b) Carry out the part work / part incomplete work of any item(s) by any means at the risk and cost of the contractor.

The Engineer-in-Charge shall determine the amount, if any, is recoverable from the contractor for completion of the part work/ part incomplete work of any item(s) taken out of his hands and execute at the risk and cost of the contractor, the liability of contractor on account of loss or damage suffered by IIM Indore because of action under this clause shall not exceed 10% of the tendered value of the work.

In determining the amount, credit shall be given to the contractor with the value of work done in all respect in the same manner and at the same rate as if it had been carried out by the original contractor under the terms of his contract, the value of contractor's materials taken over and incorporated in the work and use of plant and machinery belonging to the contractor.

The certificate of the Engineer-in-Charge as to the value of work done shall be final and conclusive against the contractor provided always that action under this clause shall only be taken after giving notice in writing to the contractor. Provided also that if the expenses incurred by the department are less than the amount payable to the contractor at his agreement rates, the difference shall not be payable to the contractor.

Any excess expenditure incurred or to be incurred by IIM Indore in completing the part work/ part incomplete work of any item(s) or the excess loss of damages suffered or may be suffered by IIM Indore as aforesaid after allowing such credit shall without prejudice to any other right or remedy available to IIM Indore in law or per as agreement be recovered from any money due to the contractor on any account, and if such money is insufficient, the contractor shall be called upon in writing and shall be liable to pay the same within 30 days.

If the contractor fails to pay the required sum within the aforesaid period of 30 days, the Engineer-in-Charge shall have the right to sell any or all of the contractors' unused materials, constructional plant, implements, temporary building at site etc. and adjust the proceeds of sale thereof towards the dues recoverable from the contractor under the contract and if thereafter there remains any balance outstanding, it shall be recovered in accordance with the provisions of the contract.

In the event of above course being adopted by the Engineer-in-Charge, the contractor shall have no claim to compensation for any loss sustained by him by reason of his having purchased or procured any materials or entered into any engagements or made any advance on any account or with a view to the execution of the work or the performance of the contract.

CLAUSE 15

Suspension of Work

- i) The contractor shall, on receipt of the order in writing of the Engineer-in-Charge, (whose decision shall be final and binding on the contractor) suspend the progress of the works or any part thereof for such time and in such manner as the Engineer-in-Charge may consider necessary so as not to cause any damage or injury to the work already done or endanger the safety thereof for any of the following reasons:
 - a) on account of any default on the part of the contractor or;
 - b) for proper execution of the works or part thereof for reasons other than the default of the contractor; or
 - c) for safety of the works or part thereof.

The contractor shall, during such suspension, properly protect and secure the works to the extent necessary and carry out the instructions given in that behalf by the Engineer-in- Charge.

- ii) If the suspension is ordered for reasons (b) and (c) in sub-para (i) above:
 - a) the contractor shall be entitled to an extension of time equal to the period of every such suspension PLUS 25%, for completion of the item or group of items of work for which a separate period of completion is specified in the contract and of which the suspended work forms a part, and;
 - b) If the total period of all such suspensions in respect of an item or group of items or work for which a separate period of completion is specified in the contract exceeds thirty days, the contractor shall, in addition, be entitled to such compensation as the Engineer-in- Charge may consider reasonable in respect of salaries and/or wages paid by the contractor to his employees and labour at site, remaining idle during the period of suspension, adding thereto 2% to cover indirect expenses of the contractor provided the contractor submits his claim supported by details to the Engineer-in-Charge within fifteen days of the expiry of the period of 30 days.
- iii) If the works or part thereof is suspended on the orders of the Engineer-in-Charge for more than three months at a time, except when suspension is ordered for reason (a) in sub para (i) above, the contractor may after receipt of such order serve a written notice on the Engineer-in-Charge requiring permission within fifteen days from receipt by the Engineer-in-Charge of the said notice, to proceed with the work or part thereof in regard to which progress has been suspended and if such permission is not granted within that time, the contractor, if he intends to treat the suspension, where it affects only a part of the works as an omission of such part by IIM Indore or where it affects whole of the works, as an abandonment of the works by IIM Indore, shall within ten days of expiry of such period of 15 days give notice in writing of his intention to the Engineer-in-Charge. In the event of the contractor treating the suspension as an abandonment of the contract by IIM Indore, he shall have no claim to payment

of any compensation on account of any profit or advantage which he might have derived from the execution of the work in full but which he could not derive in consequence of the abandonment. He shall, however, be entitled to such compensation, as the Engineer-in-Charge may consider reasonable, in respect of salaries and/or wages paid by him to his employees and labour at site, remaining idle in consequence adding to the total thereof 2% to cover indirect expenses of the contractor provided the contractor submits his claim supported by details to the Engineer-in-Charge within 30 days of the expiry of the period of 3 months.

CLAUSE 16

Action in case Work not done as per Specifications

All works under or in course of execution or executed in pursuance of the contract, shall at all times be open and accessible to the inspection and supervision of the Engineer-In-charge, his authorized subordinates in charge of the work and all the superior officers, officer of the Quality Assurance Unit of the Department or any organization engaged by the Department for Quality Assurance and of the Chief Technical Examiner's Office, and the contractor shall, at all times, during the usual working hours and at all other times at which reasonable notice of the visit of such officers has been given to the contractor, either himself be present to receive orders and instructions or have a responsible agent duly accredited in writing, present for that purpose. Orders given to the Contractor's agent shall be considered to have the same force as if they had been given to the contractor himself.

If it shall appear to the Engineer-in-charge or his authorized subordinates incharge of the work or to the Chief Engineer in charge of Quality Assurance or his subordinate officers or the officers of the organization engaged by the Department for Quality Assurance or to the Chief Technical Examiner or his subordinate officers, that any work has been executed with unsound, imperfect, or unskilful workmanship, or with materials or articles provided by him for the execution of the work which are unsound or of a quality inferior to that contracted or otherwise not in accordance with the contract, the contractor shall, on demand in writing which shall be made within twelve months (six months in the case of work costing Rs. 10 Lac and below except road work) of the completion of the work from the Engineer-in-Charge specifying the work, materials or articles complained of notwithstanding that the same may have been passed, certified and paid for forthwith rectify, or remove and reconstruct the work so specified in whole or in part, as the case may require or as the case may be, remove the materials or articles so specified and provide other proper and suitable materials or articles at his own charge and cost. In the event of the failing to do so within a period specified by the Engineer-in- Charge in his demand aforesaid, then the contractor shall be liable to pay compensation at the same rate as under clause 2 of the contract (for non-completion of the work in time) for this default.

In such case the Engineer-in-Charge may not accept the item of work at the rates applicable under the contract but may accept such items at reduced rates as the authority specified in schedule 'F' may consider reasonable during the preparation of on account bills or final bill if the item is so acceptable without detriment to the safety and utility of the item and the structure or he may reject the work outright without any payment and/or get it and other connected and incidental items rectified,

or removed and re-executed at the risk and cost of the contractor. Decision of the Engineer-in-Charge to be conveyed in writing in respect of the same will be final and binding on the contractor.

CLAUSE 17

Contractor Liable for Damages, defects during defect liability period

If the contractor or his working people or servants shall break, deface, injure or destroy any part of building in which they may be working, or any building, road, road kerb, fence, enclosure, water pipe, cables, drains, electric or telephone post or wires, trees, grass or grassland, or cultivated ground contiguous to the premises on which the work or any part is being executed, or if any damage shall happen to the work while in progress, from any cause whatever or if any defect, shrinkage or other faults appear in the work within twelve months (six months in the case of work costing Rs. Ten lacs and below except road work) after a certificate final or otherwise of its completion shall have been given by the Engineer-in-Charge as aforesaid arising out of defect or improper materials or workmanship the contractor shall upon receipt of a notice in writing on that behalf make the same good at his own expense or in default the Engineer-in-Charge cause the same to be made good by other workmen and deduct the expense from any sums that may be due or at any time thereafter may become due to the contractor, or from his security deposit or the proceeds of sale thereof or of a sufficient portion thereof. The security deposit of the contractor shall not be refunded before the expiry of twelve months (six months in the case of work costing Rs. Ten lacs and below except road work) after the issue of the certificate final or otherwise, of completion of work, or till the final bill has been prepared and passed whichever is later. Provided that in the case of road work, if in the opinion of the Engineer-in-Charge, half of the security deposit is sufficient, to meet all liabilities of the contractor under this contract, half of the security deposit will be refundable after six months and the remaining half after twelve months of the issue of the said certificate of completion or till the final bill has been prepared and passed whichever is later.

In case of Maintenance and Operation works of E&M services, the security deposit deducted from contractors shall be refunded within one month from the date of final payment or within one month from the date of completion of the maintenance contract whichever is earlier.

CLAUSE 18

Contractor to Supply Tools & Plants etc.

The contractor shall provide at his own cost all materials (except such special materials, if any, as may in accordance with the contract be supplied from the Engineer-in-Charge's stores), machinery, tools & plants as specified in schedule F. In addition to this, appliances, implements, other plants, ladders, cordage, tackle, scaffolding and temporary works required for the proper execution of the work, whether original, altered or substituted and whether included in the specifications or other documents forming part of the contract or referred to in these conditions or not, or which may be necessary for the purpose of satisfying or complying with the requirements of the Engineer-in-Charge as to any matter as to which under these conditions he is entitled to be satisfied, or which he is entitled to require together

with carriage therefore to and from the work. The contractor shall also supply without charge the requisite number of persons with the means and materials, necessary for the purpose of setting out works, and counting, weighing and assisting the measurement for examination at any time and from time to time of the work or materials. Failing his so doing, the same may be provided by the Engineer-in-Charge at the expense of the contractor and the expenses may be deducted, from any money due to the contractor, under this contract or otherwise and/or from his security deposit or the proceeds of sale thereof, or of a sufficient portions thereof.

CLAUSE 18 A

Recovery of Compensation paid to Workmen

In every case in which by virtue of the provisions sub-section (1) of Section 12, of the Workmen's Compensation Act, 1923, IIM Indore is obliged to pay compensation to a workman employed by the contractor, in execution of the works, IIM Indore will recover from the contractor, the amount of the compensation so paid; and, without prejudice to the rights of the IIM Indore under sub-section (2) of Section 12, of the said Act, IIM Indore shall be at liberty to recover such amount or any part thereof by deducting it from the security deposit or from any sum due by IIM Indore to the contractor whether under this contract or otherwise. IIM Indore shall not be bound to contest any claim made against it under sub-section (1) of Section 12, of the said Act, except on the written request of the contractor and upon his giving to IIM Indore full security for all costs for which IIM Indore might become liable in consequence of contesting such claim.

CLAUSE 18 B

Ensuring Payment and Amenities to Workers if Contractor fails

In every case in which by virtue of the provisions of the Contract Labour (Regulation and Abolition) Act, 1970, and of the Contract Labour (Regulation and Abolition) Central Rules, 1971, IIM Indore is obliged to pay any amounts of wages to a workman employed by the contractor in execution of the works, or to incur any expenditure in providing welfare and health amenities required to be provided under the above said Act and the rules under Clause 19H or under the C.P.W.D. Contractor's Labour Regulations, or under the Rules framed by Government from time to time for the protection of health and sanitary arrangements for workers employed by C.P.W.D. Contractors, IIM Indore will recover from the contractor, the amount of wages so paid or the amount of expenditure so incurred; and without prejudice to the rights of the IIM Indore under sub-section(2) of Section 20, and sub-section (4) of Section 21, of the Contract Labour (Regulation and Abolition) Act, 1970, IIM Indore shall be at liberty to recover such amount or any part thereof by deducting it from the security deposit or from any sum due by IIM Indore to the contractor whether under this contract or otherwise IIM Indore shall not be bound to contest any claim made against it under sub-section (1) of Section 20, sub-section (4) of Section 21, of the said Act, except on the written request of the contractor and upon his giving to the IIM Indore full security for all costs for which IIM Indore might become liable in contesting such claim.

CLAUSE 19

Labour Laws to be complied by the Contractor

The contractor shall obtain a valid licence (if applicable, being more than 20 labours at site) under the Contract Labour (R&A) Act, 1970, and the Contract Labour (Regulation and Abolition) Central Rules, 1971, before the commencement of the work, and continue to have a valid license until the completion of the work. **The contractor shall also comply with provisions of the Inter-State Migrant Workmen (Regulation of Employment and Conditions of Service) Act, 1979.** The contractor shall also abide by the provisions of the Child Labour (Prohibition and Regulation) Act, 1986.

The contractor shall also comply with the provisions of the building and other Construction Workers (Regulation of Employment & Conditions of Service) Act, 1996 and the building and other Construction Workers Welfare Cess Act, 1996.

Any failure to fulfil these requirements shall attract the penal provisions of this contract arising out of the resultant non-execution of the work.

CLAUSE 19A

No labour below the age of fourteen years shall be employed on the work.

CLAUSE 19 B

Payment of Wages

Payment of wages:

- i) The contractor shall pay to labour employed by him either directly or through subcontractors, wages not less than fair wages as defined in the C.P.W.D. Contractor's Labour Regulations or as per the provisions of the Contract Labour (Regulation and Abolition) Act, 1970 and the contract Labour (Regulation and Abolition) Central Rules, 1971, wherever applicable.
- ii) The contractor shall, notwithstanding the provisions of any contract to the contrary, cause to be paid fair wage to labour indirectly engaged on the work, including any labour engaged by his sub-contractors in connection with the said work, as if the labour had been immediately employed by him.
- iii) In respect of all labour directly or indirectly employed in the works for performance of the contractor's part of this contract, the contractor shall comply with or cause to be complied with the Central Public Works Department contractor's Labour Regulations made by Government from time to time in regard to payment of wages, wage period, deductions from wages recovery of wages not paid and deductions unauthorizedly made, maintenance of wage books or wage slips, publication of scale of wages and other terms of employment, inspection and submission of periodical returns and all other matters of the like nature or as per the provisions of the Contract Labour (Regulation and Abolition) Act, 1970, and the Contract Labour (Regulation and Abolition) Central Rules, 1971, wherever applicable.
- iv)
 - a) The Engineer-in-Charge concerned shall have the right to deduct from the moneys due to the contractor any sum required or estimated to be required for making good the loss suffered by a worker or workers by reason of non-fulfilment of the conditions of the contract for the benefit of the workers,

non-payment of wages or of deductions made from his or their wages which are not justified by their terms of the contract or non-observance of the Regulations.

- b) Under the provision of Minimum Wages (Central) Rules, 1950, the contractor is bound to allow to the labours directly or indirectly employed in the works one day rest for 6 days continuous work and pay wages at the same rate as for duty. In the event of default, the Engineer-in-Charge shall have the right to deduct the sum or sums not paid on account of wages for weekly holidays to any labours and pay the same to the persons entitled thereto from any money due to the contractor by the Engineer-in-Charge concerned.

In the case of Union Territory of Delhi, however, as the all inclusive minimum daily wages fixed under Notification of the Delhi Administration No.F.12(162)MWO/DAB/43884-91, dated 31-12-1979 as amended from time to time are inclusive of wages for the weekly day of rest, the question of extra payment for weekly holiday would not arise.

- v) The contractor shall comply with the provisions of the Payment of Wages Act, 1936, Minimum Wages Act, 1948, Employees Liability Act, 1938, Workmen's Compensation Act, 1923, Industrial Disputes Act, 1947, Maternity Benefits Act, 1961, and the Contractor's Labour (Regulation and Abolition) Act 1970, or the modifications thereof or any other laws relating thereto and the rules made thereunder from time to time.
- vi) The contractor shall indemnify and keep indemnified IIM Indore against payments to be made under and for the observance of the laws aforesaid and the C.P.W.D. Contractor's Labour Regulations without prejudice to his right to claim indemnity from his sub-contractors.
- vii) The laws aforesaid shall be deemed to be a part of this contract and any breach thereof shall be deemed to be a breach of this contract.
- viii) Whatever is the minimum wage for the time being, or if the wage payable is higher than such wage, such wage shall be paid by the contractor to the workmen directly without the intervention of Jamadar and that Jamadar shall not be entitled to deduct or recover any amount from the minimum wage payable to the workmen as and by way of commission or otherwise.
- ix) The contractor shall ensure that no amount by way of commission or otherwise is deducted or recovered by the Jamadar from the wage of workmen.

CLAUSE 19C

In respect of all labour directly or indirectly employed in the work for the performance of the contractor's part of this contract, the contractor shall at his own expense arrange for the safety provisions as per C.P.W.D. Safety Code framed from time to time and shall at his own expense provide for all facilities in connection therewith. In case the contractor fails to make arrangement and provide necessary facilities as

aforesaid, he shall be liable to pay a penalty as decided by the authority mentioned in Schedule F for each default and in addition, the Engineer-in- Charge shall be at liberty to make arrangement and provide facilities as aforesaid and recover the costs incurred in that behalf from the contractor.

CLAUSE 19 D

The contractor shall submit by the 4th and 19th of every month, to the Engineer-in- Charge, a true statement showing in respect of the second half of the preceding month and the first half of the current month respectively:-

- (1) the number of labourers employed by him on the work,
- (2) their working hours,
- (3) the wages paid to them,
- (4) the accidents that occurred during the said fortnight showing the circumstances under which they happened and the extent of damage and injury caused by them, and
- (5) the number of female workers who have been allowed maternity benefit according to Clause 19F and the amount paid to them.

Failing which the contractor shall be liable to pay to IIM Indore, a sum not exceeding Rs.200/- for each default or materially incorrect statement. The decision of the Competent Authority shall be final in deducting from any bill due to the contractor, the amount levied as fine and be binding on the contractor.

CLAUSE 19 E

In respect of all labour directly or indirectly employed in the works for the performance of the contractor's part of this contract, the contractor shall comply with or cause to be complied with all the rules framed by Government from time to time for the protection of health and sanitary arrangements for workers employed by the Central Public Works Department and its contractors.

CLAUSE 19 F

Leave and pay during leave shall be regulated as follows:-

1. Leave :

- i. in the case of delivery - maternity leave not exceeding 8 weeks, 4 weeks up to and including the day of delivery and 4 weeks following that day,
- ii. in the case of miscarriage - upto 3 weeks from the date of miscarriage.

2. Pay :

- i. In the case of delivery - leave pay during maternity leave will be at the rate of the women's average daily earnings, calculated on total wages earned on the days when full time work was done during a period of three months immediately preceding the date on which she gives notice that she expects to be confined or at the rate of Rupee one only a day whichever is greater.
- ii. in the case of miscarriage - leave pay at the rate of average daily earning calculated on the total wages earned on the days when full time work was done during a period of three months immediately preceding the date of such miscarriage.

3. Conditions for the grant of Maternity Leave:

No maternity leave benefit shall be admissible to a woman unless she has been employed for a total period of not less than six months immediately preceding the date on which she proceeds on leave.

4. The contractor shall maintain a register of Maternity (Benefit) in the Prescribed Form as shown in appendix -I and II, and the same shall be kept at the place of work.

CLAUSE 19 G

In the event of the contractor(s) committing a default or breach of any of the provisions of the Central Public Works Department, Contractor's Labour Regulations and Model Rules for the protection of health and sanitary arrangements for the workers as amended from time to time or furnishing any information or submitting or filing any statement under the provisions of the above Regulations and' Rules which is materially incorrect, he/they shall, without prejudice to any other liability, pay to the IIM Indore a sum not exceeding Rs.200/- for every default, breach or furnishing, making, submitting, filing such materially incorrect statements and in the event of the contractor(s) defaulting continuously in this respect, the penalty may be enhanced to Rs.200/- per day for each day of default subject to a maximum of 5 per cent of the estimated cost of the work put to tender. The decision of the Engineer-in-Charge shall be final and binding on the parties. Should it appear to the Engineer-in-Charge that the contractor(s) is/are not properly observing and complying with the provisions of the C.P.W.D. Contractor's Labour Regulations and Model Rules and the provisions of the Contract Labour (Regulation and Abolition) Act 1970, and the Contract Labour (R& A) Central Rules 1971, for the protection of health and sanitary arrangements for work-people employed by the contractor(s) (hereinafter referred as "the said Rules") the Engineer-in-Charge shall have power to give notice in writing to the contractor(s) requiring that the said Rules be complied with and the amenities prescribed therein be provided to the work-people within a reasonable time to be specified in the notice. If the contractor(s) shall fail within the period specified in the notice to comply with and/observe the said Rules and to provide the amenities to the work-people as aforesaid, the Engineer-in-Charge shall have the power to provide the amenities hereinbefore mentioned at the cost of the contractor(s). The contractor(s) shall erect, make and maintain at his/their own expense and to approved standards all necessary huts and sanitary arrangements required for his/their work-people on the site in connection with the execution of the works, and if the same shall not have been erected or constructed, according to approved standards, the Engineer-in-Charge shall have power to give notice in writing to the contractor(s) requiring that the said huts and sanitary arrangements be remodelled and/or reconstructed according to approved standards, and if the contractor(s) shall fail to remodel or reconstruct such huts and sanitary arrangements according to approved standards within the period specified in the notice, the Engineer-in-Charge shall have the power to remodel or reconstruct such huts and sanitary arrangements according to approved standards at the cost of the contractor(s).

CLAUSE 19 H

The contractor(s) shall at his/their own cost arrange appropriate accommodation for his/ their labour employed which should have proper doors windows, ventilation, water supply, drainage, & sanitary installation etc.

CLAUSE 19 I

The Engineer-in-Charge may require the contractor to dismiss or remove from the site of the work any person or persons in the contractors' employ upon the work who may be incompetent or misconduct himself and the contractor shall forthwith comply with such requirements. In respect of maintenance/repair or renovation works etc. where the labour have an easy access to the individual houses, the contractor shall issue identity cards to the labourers, whether temporary or permanent and he shall be responsible for any untoward action on the part of such labour. AE/JE will display a list of contractors working in the colony/Blocks on the notice board in the colony and also at the service centre, to apprise the residents about the same.

CLAUSE 19J

It shall be the responsibility of the contractor to see that the building under construction is not occupied by anybody unauthorized during construction, and is handed over to the Engineer-in-Charge with vacant possession of complete building. If such building though completed is occupied illegally, then the Engineer-in-Charge shall have the option to refuse to accept the said building/buildings in that position. Any delay in acceptance on this account will be treated as the delay in completion and for such delay, a levy upto 5% of tendered value of work may be imposed by the Chief Engineer whose decision shall be final both with regard to the justification and quantum and be binding on the contractor.

However, the Chief Engineer, through a notice, may require the contractor to remove the illegal occupation any time on or before construction and delivery.

CLAUSE 19K

Employment of skilled/semi-skilled workers

The contractor shall, at all stages of work, deploy skilled/semi-skilled tradesmen who are qualified and possess certificate in particular trade from CPWD Training Institute/Industrial Training Institute/National Institute of construction Management and Research (NICMAR)/ National Academy of Construction, CIDC or any similar reputed and recognized Institute managed/ certified by State/Central Government. The number of such qualified tradesmen shall not be less than 20% of total skilled/semi-skilled workers required in each trade at any stage of work. The contractor shall submit number of man days required in respect of each trade, its scheduling and the list of qualified tradesmen along with requisite certificate from recognized Institute to Engineer in charge for approval. Notwithstanding such approval, if the tradesmen are found to have inadequate skill to execute the work of respective trade, the contractor shall substitute such tradesmen within two days of written notice from Engineer-in- Charge. Failure on the part of contractor to obtain approval of Engineer-in-Charge or failure to deploy qualified tradesmen will attract a compensation to be paid by contractor at the rate specified in schedule 'F' per such tradesman per day. Decision of Engineer in Charge as to whether particular tradesman

possesses requisite skill and amount of compensation in case of default shall be final and binding.

Provided always, that the provisions of this clause, shall not be applicable for works with estimated cost put to tender being less than Rs. 5 crores.

For work costing more than Rs. 10 Crores, and upto Rs. 50 Crores, the contractor shall arrange on site training as per National Skill Development Corporation (NSDC) norms for at least 20% of the unskilled workers engaged in the project in co-ordination with the CPWD Regional Training Institute & National Skill Development Corporation (NSDC) for certification at the level of skilled/semiskilled tradesmen.

For work costing more than Rs. 50 Crores, the contractor shall arrange on site training as per National Skill Development Corporation (NSDC) norms for at least 30% of the unskilled worker engaged in the project in coordination with the CPWD Regional Training Institute & National Skill Development Corporation (NSDC) for certification at the level of skilled/semiskilled tradesmen. The cost of such training as stated above shall be born by the Government. The necessary space and workers shall be provided by the contractor and no claim what so ever shall be entertained.

CLAUSE 19L- - Deleted.

CLAUSE 20

Minimum Wages Act to be complied with

The contractor shall comply with all the provisions of the Minimum Wages Act, 1948, and Contract Labour (Regulation and Abolition) Act, 1970, amended from time to time and rules framed thereunder and other labour laws affecting contract labour that may be brought into force from time to time.

CLAUSE 21

Work not to be sublet. Action in case of insolvency

The contract shall not be assigned or sublet without the written approval of the Engineer-in -Charge. And if the contractor shall assign or sublet his contract, or attempt to do so, or become insolvent or commence any insolvency proceedings or make any composition with his creditors or attempt to do so, or if any bribe, gratuity, gift, loan, perquisite, reward or advantage pecuniary or otherwise, shall either directly or indirectly, be given, promised or offered by the contractor, or any of his servants or agent to any public officer or person in the employ of IIM Indore in any way relating to his office or employment, or if any such officer or person shall become in any way directly or indirectly interested in the contract, the Engineer-in-Charge on behalf of the Director, IIM Indore shall have power to adopt the course specified in Clause 3 hereof in the interest of IIM Indore and in the event of such course being adopted, the consequences specified in the said Clause 3 shall ensue.

CLAUSE 22

All sums payable by way of compensation under any of these conditions shall be considered as reasonable compensation to be applied to the use of IIM Indore without reference to the actual loss or damage sustained and whether or not any damage shall have been sustained.

CLAUSE 23

Changes in firm's Constitution to be intimated

Where the contractor is a partnership firm, the previous approval in writing of the Engineer-in-Charge shall be obtained before any change is made in the constitution of the firm. Where the contractor is an individual or a Hindu undivided family business concern, such approval as aforesaid shall likewise be obtained before the contractor enters into any partnership agreement where under the partnership firm would have the right to carry out the works hereby undertaken by the contractor. If previous approval as aforesaid is not obtained, the contract shall be deemed to have been assigned in contravention of Clause 21 hereof and the same action may be taken, and the same consequences shall ensue as provided in the said Clause 21.

CLAUSE 24

Life Cycle cost

The contractor shall be responsible for safety, quality and soundness of the buildings including structural elements beyond maintenance period. The contractor shall have obligation to rectify such defects minimum up to 5 (five) years from the date of completion of work. The defects have to be rectified within a reasonable time not exceeding three months after issue of notice by Engineer- in- Charge.

CLAUSE 25

Resolution of Disputes and Disagreements

If any dispute or difference of any kind whatsoever shall arise between the parties in connection with or arising out of this Agreement or out of the breach termination or invalidity of this Agreement thereof, the parties shall resolve them by resorting to the following :

- The Party shall attempt within a period of 7 days after receipt of notice by the other party of the existence of a dispute, settle such dispute in the first instance by mutual discussions between the parties represented by the **Contractor** and Chief Engineer of the institute.
- If the dispute cannot be settled by mutual discussion within 7 days the matter shall be referred to the Director IIM Indore, whose decision shall be full, final & binding on the parties.

CLAUSE 26

Contractor to indemnify IIM Indore against Patent Rights

The contractor shall fully indemnify and keep indemnified the Director, IIM Indore against any action, claim or proceeding relating to infringement or use of any patent or design or any alleged patent or design rights and shall pay any royalties which may be payable in respect of any article or part thereof included in the contract. In the event of any claims made under or action brought against IIM Indore in respect of any such matters as aforesaid, the contractor shall be immediately notified thereof and the contractor shall be at liberty, at his own expense, to settle any dispute or to conduct any litigation that may arise there from, provided that the contractor shall

not be liable to indemnify the Director, IIM Indore if the infringement of the patent or design or any alleged patent or design right is the direct result of an order passed by the Engineer-in-Charge in this behalf.

CLAUSE 27

Lump sum Provisions in Tender

When the estimate on which a tender is made includes lump sum in respect of parts of the work, the contractor shall be entitled to payment in respect of the items of work involved or the part of the work in question at the same rates as are payable under this contract for such items, or if the part of the work in question is not, in the opinion of the Engineer-in-Charge payable of measurement, the Engineer-in-Charge may at his discretion pay the lump-sum amount entered in the estimate, and the certificate in writing of the Engineer-in-Charge shall be final and conclusive against the contractor with regard to any sum or sums payable to him under the provisions of the clause.

CLAUSE 28

Action where no Specifications are specified

In the case of any class of work for which there is no such specifications as referred to in Clause 11, such work shall be carried out in accordance with the Bureau of Indian Standards Specifications. In case there are no such specifications in Bureau of Indian Standards, the work shall be carried out as per manufacturers' specifications, if not available then as per District Specifications. In case there are no such specifications as required above, the work shall be carried out in all respects in accordance with the instructions and requirements of the Engineer-in-Charge.

CLAUSE 29

Withholding and lien in respect of sum due from contractor

- (i) Whenever any claim or claims for payment of a sum of money arises out of or under the contract or against the contractor, the Engineer-in-Charge or the IIM Indore shall be entitled to withhold and also have a lien to retain such sum or sums in whole or in part from the security, if any deposited by the contractor and for the purpose aforesaid, the Engineer in- Charge or the IIM Indore shall be entitled to withhold the security deposit, if any, furnished as the case may be and also have a lien over the same pending finalisation or adjudication of any such claim. In the event of the security being insufficient to cover the claimed amount or amounts or if no security has been taken from the contractor, the Engineer-in-Charge or the IIM Indore shall be entitled to withhold and have a lien to retain to the extent of such claimed amount or amounts referred to above, from any sum or sums found payable or which may at any time thereafter become payable to the contractor under the same contract or any other contract with the Engineer-in-Charge of the IIM Indore or any contracting person through the Engineer-in-Charge pending finalization of adjudication of any such claim.

It is an agreed term of the contract that the sum of money or moneys so withheld or retained under the lien referred to above by the Engineer-in-Charge or IIM Indore will be kept withheld or retained as such by the Engineer-in-Charge or IIM Indore till the claim arising out of or under the contract is determined by the

arbitrator(if the contract is governed by the arbitration clause) by the competent court, as the case may be and that the contractor will have no claim for interest or damages whatsoever on any account in respect of such withholding or retention under the lien referred to above and duly notified as such to the contractor. For the purpose of this clause, where the contractor is a partnership firm or a limited company, the Engineer-in-Charge or the IIM Indore shall be entitled to withhold and also have a lien to retain towards such claimed amount or amounts in whole or in part from any sum found payable to any partner/limited company as the case may be, whether in his individual capacity or otherwise.

- (ii) IIM Indore shall have the right to cause an audit and technical examination of the works and the final bills of the contractor including all supporting vouchers, abstract, etc., to be made after payment of the final bill and if as a result of such audit and technical examination any sum is found to have been overpaid in respect of any work done by the contractor under the contract or any work claimed to have been done by him under the contract and found not to have been executed, the contractor shall be liable to refund the amount of overpayment and it shall be lawful for IIM Indore to recover the same from him in the manner prescribed in sub-clause (i) of this clause or in any other manner legally permissible; and if it is found that the contractor was paid less than what was due to him under the contract in respect of any work executed by him under it, the amount of such under payment shall be duly paid by IIM Indore to the contractor, without any interest thereon whatsoever.

Provided that the IIM Indore shall not be entitled to recover any sum overpaid, nor the contractor shall be entitled to payment of any sum paid short where such payment has been agreed upon between the Chief Engineer or Executive Engineer on the one hand and the contractor on the other under any term of the contract permitting payment for work after assessment by the Chief Engineer or the Executive Engineer.

CLAUSE 29A

Lien in respect of claims in other Contracts

Any sum of money due and payable to the contractor (including the security deposit returnable to him) under the contract may be withheld or retained by way of lien by the Engineer-in-Charge or the IIM Indore or any other contracting person or persons through Engineer-in-Charge against any claim of the Engineer-in-Charge or IIM Indore or such other person or persons in respect of payment of a sum of money arising out of or under any other contract made by the contractor with the Engineer- in-Charge or the IIM Indore or with such other person or persons.

It is an agreed term of the contract that the sum of money so withheld or retained under this clause by the Engineer-in-Charge or the IIM Indore will be kept withheld or retained as such by the Engineer-in-Charge or the IIM Indore or till his claim arising out of the same contract or any other contract is either mutually settled or determined by the arbitration clause or by the competent court, as the case may be and that the contractor shall have no claim for interest or damages whatsoever on

this account or on any other ground in respect of any sum of money withheld or retained under this clause and duly notified as such to the contractor.

CLAUSE 30

Unfiltered water Supply

The contractor(s) shall make his/their own arrangements for water required for the work and nothing extra will be paid for the same. This will be subject to the following conditions.

- i. That the water used by the contractor(s) shall be fit for construction purposes to the satisfaction of the Engineer-in-Charge.
- ii. The Engineer-in-Charge shall make alternative arrangements for supply of water at the risk and cost of contractor(s) if the arrangements made by the contractor(s) for procurement of water are in the opinion of the Engineer-in-Charge, unsatisfactory.

CLAUSE 31

Hire of Plant & Machinery

The contractor shall arrange at his own expense all tools, plant, machinery and equipment (hereinafter referred to as T&P) required for execution of the work

CLAUSE 32

Employment of Technical Staff and employees

Contractors Superintendence, Supervision, Technical Staff & Employees

- (i) The contractor shall provide all necessary superintendence during execution of the work and all along thereafter as may be necessary for proper fulfilling of the obligations under the contract.

The contractor shall immediately after receiving letter of acceptance of the tender and before commencement of the work, intimate in writing to the Engineer-in-Charge, the name(s), qualifications, experience, age, address(s) and other particulars along with certificates, of the principal technical representative to be in charge of the work and other technical representative(s) who will be supervising the work. Minimum requirement of such technical representative(s) and their qualifications and experience shall not be lower than specified in Schedule 'F'. The Engineer-in-Charge shall within 3 days of receipt of such communication intimate in writing his approval or otherwise of such a representative(s) to the contractor. Any such approval may at any time be withdrawn and in case of such withdrawal, the contractor shall appoint another such representative(s) according to the provisions of this clause. Decision of the tender accepting authority shall be final and binding on the contractor in this respect. Such a principal technical representative and other technical representative(s) shall be appointed by the contractor soon after receipt of the approval from Engineer-in-charge and shall be available at site before start of work.

All the provisions applicable to the principal technical representative under the Clause will also be applicable to other technical representative(s) The principal technical representative and other technical representative(s) shall be present at the site of work for supervision at all times when any construction activity is

in progress and also present himself/themselves, as required, to the Engineer-in-Charge and/or his designated representative to take instructions. Instructions given to the principal technical representative or other technical representative(s) shall be deemed to have the same force as if these have been given to the contractor. The principal technical representative and other technical representative(s) shall be actually available at site fully during all stages of execution of work, during recording/checking/test checking of measurements of works and whenever so required by the Engineer-in-Charge and shall also note down instructions conveyed by the Engineer-in-Charge or his designated representative(s) in the site order book and shall affix his/their signature in token of noting down the instructions and in token of acceptance of measurements/ checked measurements/ test checked measurements. The representative(s) shall not look after any other work. Substitutes, duly approved by Engineer-in-Charge of the work in similar manner as aforesaid shall be provided in event of absence of any of the representative(s) by more than two days.

If the Engineer-in-Charge, whose decision in this respect is final and binding on the contractor, is convinced that no such technical representative(s) is/are effectively appointed or is/are effectively attending or fulfilling the provision of this clause, a recovery (non-refundable) shall be effected from the contractor as specified in Schedule 'F' and the decision of the Engineer-In-Charge as recorded in the site order book and measurement recorded checked/test checked in Measurement Books shall be final and binding on the contractor. Further if the contractor fails to appoint suitable technical Principal technical representative and/or other technical representative(s) and if such appointed persons are not effectively present or are absent by more than two days without duly approved. Substitute or do not discharge their responsibilities satisfactorily, the Engineer-in-Charge shall have full powers to suspend the execution of the work until such date as suitable other technical representative(s) is/are appointed and the contractor shall be held responsible for the delay so caused to the work. The contractor shall submit a certificate of employment of the technical representative(s) (in the form of copy of Form-16 or CPF deduction issued to the Engineers employed by him) along with every on account bill final bill and shall produce evidence if at any time so required by the Engineer-in-Charge.

- (ii) The contractor shall provide and employ on the site only such technical assistants as are skilled and experienced in their respective fields and such foremen and supervisory staff as are competent to give proper supervision to the work.

The contractor shall provide and employ skilled, semiskilled and unskilled labour as is necessary for proper and timely execution of the work.

The Engineer-in-Charge shall be at liberty to object to and require the contractor to remove from the works any person who in his opinion misconducts himself, or is incompetent or negligent in the performance of his duties or

whose employment is otherwise considered by the Engineer-in-Charge to be undesirable. Such person shall not be employed again at works site without the written permission of the Engineer-in-Charge and the persons so removed shall be replaced as soon as possible by competent substitutes

CLAUSE 33 -

Levy/Taxes Payable by Contractors: -

- (i) GST, Building and other Construction Workers Welfare Cess or any other tax, levy or Cess in respect of input for or output by this contract shall be payable by the contractor and IIM Indore shall not entertain any claim whatsoever in this respect except as provided under Clause 38.

- (ii) The contractor shall deposit royalty and obtain necessary permit for supply of the red bajri, stone, kankar, etc. from local authorities.

If pursuant to or under any law, notification or order any royalty, cess or the like becomes payable by the IIM Indore and does not any time become payable by the contractor to the State Government, Local authorities in respect of any material used by the contractor in the works, then in such a case, it shall be lawful to the IIM Indore and it will have the right and be entitled to recover the amount paid in the circumstances as aforesaid from dues of the contractor

CLAUSE 34

Conditions for reimbursement of levy/taxes if levied after receipt of tenders

- i. All tendered rates shall be inclusive of any tax, levy or cess applicable on last stipulated date of receipt of tender including extension if any. No adjustment i.e. increase or decrease shall be made for any variation in the rate of GST, Building and Other Construction Workers Welfare Cess or any tax, levy or cess applicable on inputs. However, effect of variation in rates of GST or Building and Other Construction Workers Welfare Cess or imposition or repeal of any other tax, levy or cess applicable on output of the works contract shall be adjusted on either side, increase or decrease. Provided further that for Building and Other Construction Workers Welfare Cess or any tax (other than GST), levy or cess varied or imposed after the last date of receipt of tender including extension if any, any increase shall be reimbursed to the contractor only if the contractor necessarily and properly pays such increased amount of taxes/levies/cess. Provided further that such increase including GST shall not be made in the extended period of contract for which the contractor alone is responsible for delay as determined by authority for extension of time under Clause 5 in Schedule F.
- ii. The contractor shall keep necessary books of accounts and other documents for the purpose of this condition as may be necessary and shall allow inspection of the same by a duly authorized representative of the IIM Indore and/or the Engineer-in-Charge and shall also furnish such other information/document as the Engineer-in-Charge may require from time to time.
- iii. The contractor shall, within a period of 30 days of the imposition of any such further tax or levy or cess, or variation or repeal of such tax or levy or cess give a written notice thereof to the Engineer-in-charge that the same is given pursuant to this condition, together with all necessary information relating thereto.

CLAUSE 35

Termination of Contract on death of contractor

Without prejudice to any of the rights or remedies under this contract, if the contractor dies, the Executive Engineer on behalf of the Director, IIM Indore shall have the option of terminating the contract without compensation to the contractor.

CLAUSE 36

If relative working in IIM INDORE then the contractor not allowed to tender

The contractor shall not be permitted to tender for works in the IIM Indore responsible for award and execution of contracts if his near relative is posted in IIM Indore as any capacity. He shall also intimate the names of persons who are working with him in any capacity or are subsequently employed by him and who are near relatives to any Officer in the IIMI. Any breach of this condition by the contractor would render him liable to be removed from the approved list of contractors of this Department. If however the contractor is registered in any other department, he shall be debarred from tendering in IIMI for any breach of this condition.

NOTE: By the term “near relatives” is meant wife, husband, parents and grandparents, children and grandchildren, brothers and sisters, uncles, aunts and cousins and their corresponding in-laws.

CLAUSE 37

No Gazetted Engineer to work as Contractor within one year of retirement

No engineer of gazetted rank or other gazetted officer employed in engineering or administrative duties in an engineering department of the IIM Indore shall work as a contractor or employee of a contractor for a period of one year after his retirement from IIM Indore service without the previous permission of IIM Indore in writing. This contract is liable to be cancelled if either the contractor or any of his employees is found at any time to be such a person who had not obtained the permission of IIM Indore as aforesaid, before submission of the tender or engagement in the contractor's service, as the case may be.

CLAUSE 38

Theoretical conception of Material

- i. After completion of the work and also at any intermediate stage in the event of Non reconciliation of materials issued theoretical quantity of materials used in the work shall be calculated on the basis and method given hereunder:-
 - (a) Quantity of cement & bitumen shall be calculated on the basis of quantity of cement & bitumen required for different items of work as shown in the Schedule of Rates mentioned in Schedule 'F'. In case any item is executed for which standard constants for the consumption of cement or bitumen are not available in the above mentioned schedule/statement or cannot be derived from the same shall be calculated on the basis of standard formula to be laid down by the Engineer-in-Charge.
 - (b) Theoretical quantity of steel reinforcement or structural steel sections shall be taken as the quantity required as per design or as authorized by Engineer-in-Charge, including authorized lappages, chairs etc. plus 3% wastage due to cutting into pieces, such theoretical quantity being determined and compared with the actual issues each diameter wise, section wise and category wise separately.

(c) Theoretical quantity of G.I. & C.I. or other pipes, conduits, wires and cables, pig lead and G.I./M.S. sheets shall be taken as quantity actually required and measured plus 5% for wastage due to cutting into pieces (except in the case of G.I./M.S. sheets it shall be 10%), such determination & comparison being made diameter wise & category wise.

(d) For any other material as per actual requirements.

Over the theoretical quantities of materials so computed a variation shall be allowed as specified in Schedule 'F' For non scheduled items, the decision of the Chief Engineer regarding theoretical quantities of materials which should have been actually used, shall be final and binding on the contractor.

- ii. The said action under this clause is without prejudice to the right of the IIM Indore to take action against the contractor under any other conditions of contract for not doing the work according to the prescribed specifications.

CLAUSE 39

Compensation during warlike situations

The work (whether fully constructed or not) and all materials, machines, tools and plants, scaffolding, temporary buildings and other things connected therewith shall be at the risk of the contractor until the work has been delivered to the Engineer-in-Charge and a certificate from him to that effect obtained. In the event of the work or any materials properly brought to the site for incorporation in the work being damaged or destroyed in consequence of hostilities or warlike operation, the contractor shall when ordered (in writing) by the Engineer-in-Charge to remove any debris from the site, collect and properly stack or remove in store all serviceable materials salvaged from the damaged work and shall be paid at the contract rates in accordance with the provision of this agreement for the work of clearing the site of debris, stacking or removal of serviceable material and for reconstruction of all works ordered by the Engineer-in-Charge, such payments being in addition to compensation upto the value of the work originally executed before being damaged or destroyed and not paid for. In case of works damaged or destroyed but not already measured and paid for, the compensation shall be assessed by the Executive Engineer upto Rs.2,00,000/- and by the Chief Engineer concerned for a higher amount. The contractor shall be paid for the damages/destruction suffered and for restoring the material at the rate based on analysis of rates tendered for in accordance with the provision of the contract. The certificate of the Engineer-in-Charge regarding the quality and quantity of materials and the purpose for which they were collected shall be final and binding on all parties to this contract.

Provided always that no compensation shall be payable for any loss in consequence of hostilities or warlike operations (a) unless the contractor had taken all such precautions against air raid as are deemed necessary by the A.R.P. Officers or the Engineer-in-Charge (b) for any material etc. not on the site of the work or for any tools, plant, machinery, scaffolding, temporary building and other things not intended for the work.

In the event of the contractor having to carry out reconstruction as aforesaid, he shall be allowed such extension of time for its completion as is considered reasonable by the Executive Engineer.

CLAUSE 40

Apprentices Act provisions to be complied with

The contractor shall comply with the provisions of the Apprentices Act, 1961 and the rules and orders issued thereunder from time to time. If he fails to do so, his failure will be a breach of the contract and the Chief Engineer may, in his discretion, cancel the contract. The contractor shall also be liable for any pecuniary liability arising on account of any violation by him of the provisions of the said Act.

CLAUSE 41

Release of Security deposit after labour clearance

Release of Security Deposit of the work shall not be refunded till the contractor produces a clearance deposit after labour certificate from the Labour Officer. As soon as the work is virtually complete the contractor shall apply for the clearance certificate to the Labour Officer under intimation to the Engineer-in-Charge. The Engineer-in-Charge, on receipt of the said communication, shall write to the Labour Officer to intimate if any complaint is pending against the contractor in respect of the work. If no complaint is pending, on record till after 3 months after completion of the work and/or no communication is received from the Labour Officer to this effect till six months after the date of completion, it will be deemed to have received the clearance certificate and the Security Deposit will be released if otherwise due.

N. Proforma of Schedules

SCHEDULE “A”

Schedule of quantities - as per Financial Bid.

SCHEDULE ‘B”

Schedule of materials to be issued to the contractor. - Deleted.

SCHEDULE “C”

Tools and plants to be hired to the contractor - Deleted.

SCHEDULE “D”

Extra schedule for specific requirements/document for the work, if any. - To be intimated later if required.

SCHEDULE “E”

Reference to General Conditions of contract laid down in the tender document.

Name of Work	“Making, Supply & Installation of Furniture /Fixtures in Executive Residence-2 at IIM Indore.”
Estimated Cost Put to Tender (Including Goods & Service Tax)	Rs. 2,51,86,754/- (Rupees Two Crore Fifty One Lakh Eighty Six Thousand Seven Hundred and Fifty Four Only)
EMD Amount	Rs. 5,03,735 /- (Rs. Five Lakh Three Thousand Seven Hundred Thirty Five Only) by e-payment through electronic mode (NEFT/ RTGS)
Performance Guarantee	3 (THREE) % of tendered value
Security Deposit	2.5 % of tendered value

SCHEDULE “F”

General Rules & Directions

- Officer inviting tender: The Chief Engineer, IIM Indore on behalf of the Director, IIM Indore
- Maximum percentage for quantity of items of work to be executed beyond which rates are to be determined in accordance with Clauses 12.2 & 12.3.: 50 %

Definitions:

2(v)	Engineer-in-Charge	Chief Engineer, IIM Indore
2(viii)	Accepting Authority	Director, IIM Indore
2(x)	Percentage on cost of materials and labour to cover all overheads and profits	15%
2(xi)	Standard Schedule of Rates	CPWD DSR 2021 for civil items
2(xii)	Department	Project Department, IIM Indore
9(ii)	Standard CPWD contract Form GCC 2020, CPWD Form 7/ 8 as modified & corrected	Upto date.

Clause 1

Time allowed for submission of Performance Guarantee from the date of issue of letter of acceptance : **7 Days**

Clause 2

- i. Authority for fixing compensation under clause 2. : Director, IIM Indore
- ii. Compensation for delay of work : 2% (two Percent) per week of delay to be computed on per day basis

Provided always that the total amount of compensation for delay to be paid under this Condition shall not exceed 10% of the Tendered Value of work or of the Tendered Value of the item or group of items of work for which a separate period of completion is originally given.

Clause 2A

Whether Clause 2A shall be applicable : **No.**

Clause 5

Number of days from the date of issue of letter of acceptance for reckoning date of start: **As per LOI/ WO.**

Total time allowed for completion of work: 60 (Sixty) Days.

Authority to decide:

- (i) Extension of time : Director, IIM Indore

(ii) Shifting of date of start in case of delay in handing over of site
: Chief Engineer, IIM Indore

Clause 7

Gross work to be done together with net payment /adjustment of advances for material collected, if any, since the last such payment for being eligible to interim payment: **As per tender.**

Clause 10A

List of testing equipment to be provided by the contractor at site lab.- **Deleted.**

Clause 10 C - Deleted.

Clause 10 CC - Deleted

Clause 11

Specifications to be followed for execution of work:

Relevant BIS code, CPWD Specifications with up-to-date correction slips and OEMs specifications as applicable and or as per the direction of Engineer-in-Charge.

Clause 12

Type of work: **“Making, Supply & Installation of Furniture /Fixtures in Executive Residence-2 at IIM Indore.”**

12.2 & 12.3

Deviation Limit beyond which clauses 12.2 & 12.3 shall apply for work : 50%

Clause 16

Competent Authority for Deciding reduced rates : Chief Engineer, IIM Indore.

Clause 25

Resolution of Disputes and Disagreements

If any dispute or difference of any kind whatsoever shall arise between the parties in connection with or arising out of this Agreement or out of the breach termination or invalidity of this Agreement thereof, the parties shall resolve them by resorting to the following :

- The Party shall attempt within a period of 7 days after receipt of notice by the other party of the existence of a dispute, settle such dispute in the first instance

by mutual discussions between the parties represented by the **Contractor** and Chief Engineer of the institute.

- If the dispute cannot be settled by mutual discussion within 7 days the matter shall be referred to the Director IIM Indore, whose decision shall be full, final & binding on the parties.

Clause 32

Requirement of Technical Representative(s) and recovery Rate

Sl n	Minimum Qualification of Technical Representative	Discipline	Designation (Principal Technical /Technical representative)	Minimum Experience	Number of Engineers/ Representatives	Rate at which recovery shall be made from the contractor in the event of not fulfilling provision of clause 32	
						Figures	Words
1	Graduate Engineer/ Diploma Engineer	Civil Engineering	Principal Technical Representatives (Project Manager cum Planning/ Quality/ Site/ billing Engineers)	Graduate Engineer with minimum 2 year experience/ Diploma holder with minimum 5 year experience	1+1	Rs. 15,000/- per month	Rupees fifteen Thousand only

Assistant Engineers retired from Government services that are holding Diploma will be treated at par with Graduate Engineers.

0. Special Conditions of Contract

1. The tenderer shall acquaint himself with the proposed site of work.
2. If for any reasons, any part of the site is not available temporarily for some time for part of the work under the contract, the agreed construction schedule shall be suitably modified and contractor shall diligently divert his men and materials to utilize them appropriately, profitably and no claim of damages whatsoever shall be entertained on this account. However, the contractor shall be allowed extension of time for completing the work as deemed fit by the competent authority. The contractor shall also not be entitled to any compensation for any loss suffered by him and revision in the rates quoted by him.
 - (a) On account of delay in commencing the work by the contractor.
 - (b) On account of reduction in the scope of work.
 - (c) On account of suspension of work or abandoned after award of work.
3. The contractor shall make his own arrangement for obtaining electric connection required for execution of work and make necessary payments directly to the concerned departments and nothing extra shall be payable on this account. The contractor shall make his own arrangement for water suitable for construction.
4. On account of security consideration, some restrictions may be imposed by the security staff on the working and/ movement of men and materials etc. The contractor shall be bound to follow all such restrictions/ instructions and he shall organise his work accordingly. No claim on this account, whatsoever, shall be payable.
5. The contractor shall take all precautions to avoid accidents by exhibiting necessary caution boards day and night, speed limit boards, red flags, red lights and providing barriers. He shall be responsible for all damages and accidents caused to existing/ new work due to negligence on his part. No hindrance shall be caused to traffic during the execution of the work.
6. The contractor shall be responsible for the watch and ward of all materials brought by the contractor to site against pilferage and breakage during the period of installation and thereafter till the works are physically handed over to the department.
7. The contractor shall take all preventive measures against any damage caused by rain, snowfall, floods or any other natural calamity, whatsoever during the execution of the work. The contractor shall be fully responsible for any damage to the Owners property and to the work for which the payment has been advanced to him under the contract. However, the contractor shall maintain an equal to the payment received against the work done, at his own cost. This will also cover the defect liability period. This shall be favouring the Director, Indian Institute of Management Indore. Nothing extra on this account shall be payable to the contractor for maintaining such insurance Policy.
8. The work will be carried out in the manner complying, in all respects, with the requirements of relevant bye-laws of the local body under the jurisdiction of which the work is to be executed or as directed by the Engineer-in-Charge and nothing extra shall be paid on this account.

9. The contractor shall comply with proper and legal orders and directions of the local or public authority or municipality and abide by their rules and regulations and pay all fees and charges which may be liable.
10. The contractor shall give due notices to Municipal, Police and/or other authorities that may be required under the law/rules under force in the area and obtain all requisite licenses for temporary obstructions / enclosures and pay all charges which may be leviable on account of his execution of work under the agreement. Nothing extra shall be payable on this account.
11. All materials to be incorporated in the work shall be arranged by the contractor and shall be in accordance with the specifications laid down.
12. The tenderer shall use materials bearing ISI Certification Mark unless otherwise specified or allowed in writing by the Engineer-in-Charge. Any material banned by the department shall not be used in the work.
13. The contractor shall submit to the Engineer-in-charge samples of all materials for approval. Such samples of materials which affect aesthetics of the work shall also be got approved from the Engineer-in-charge of the project before procuring bulk supplies. These approved samples shall be preserved and retained in the custody of the Engineer-in-charge as standards of materials till the completion of the work. The cost of such samples shall be borne by the Contractor and nothing shall be payable on this account over the Agreement rates.
14. The contractor shall be required to get all the necessary mandatory and other tests as per the specifications/ IS codes, carried out on materials/ work from an approved laboratory as per the direction of the Engineer-in-charge. The testing charges and conveyance from the site shall be borne by the contractor.
15. In case any material / work is found sub-standard the same shall be rejected by the Engineer-in-charge/ Architect representative and the same shall be removed from the site of work within 48 hours, failing which the same shall be got removed by the Engineer-in-charge at the risk and cost of the contractor without giving any further notice and time.
16. In order to ensure quality of work during its execution, the Engineer-in-charge representative may require samples for mandatory or routine testing of materials. All costs of these samples, their packaging, conveyance from the site to the testing laboratory and return, shall be borne by the contractor.
17. Even ISI marked materials may be subjected to quality test at the discretion of the Engineer-in-charge/ Architect. Whenever ISI marked materials are brought to the site of work the contractor shall, if required by the Engineer-in-charge/ Architect, furnish manufacturer's test certificate or test certificate from approved testing laboratory to establish that the materials procured by the contractor, satisfy the provisions of relevant ISI codes. The testing charges shall be borne by the contractor. However cement/steel will be necessarily tested before start of work and also during the execution of work as per the requirements of specifications and will not be used till test certificates are obtained and approved by Engineer-in-Charge/ Architect.
18. The contractor shall supply free of charge the material required for testing. The cost of tests shall be borne by the contractor.

19. The work shall be executed and measured in metric system. The metric dimensions given in the schedule of quantities and drawing etc. shall be followed. (The dimension in FPS units wherever indicated are for guidance only) The figures in the drawings shall be followed.
20. The contractor shall be responsible for completing the work and for satisfying all terms and conditions of the Contract without any extra payment over his quoted rates unless otherwise specified. The contractor shall quote his rate for various items of work accordingly and no claim whatsoever shall be entertained for any incidental or extra work involved in the execution of the work as per nomenclature of the item and the specifications indicated in the tender documents.
21. Subject to the nomenclature of the item as per schedule of quantities, the specification indicated in the tender documents, the rates quoted shall include cost of all materials including royalty and taxes if any, labour, sundry inputs, execution of work at all heights, levels, pattern and design for all leads, lifts and depths including overhead charges and contractor's profit. Nothing extra shall be paid on this account.
22. The rate shall be inclusive of making design, pattern and execution of work as per Architectural and structural drawings, at all levels and heights.
23. The rates shall be inclusive of making any holes in walls/ RCC work for fixing any fixture/ frame work and making good the structure to its original shape and finish.
24. Other agencies doing works related with this project will also simultaneously execute the works and the contractor shall afford necessary co-ordination for un-hindered completion of these sub-works.
25. The contractor shall continue to maintain watch and ward to safeguard the Owner's property in his possession until the same is formally handed over as per directions of the Engineer-in-charge. Nothing extra over agreement rates shall be paid on this account.
26. The quantities of various items incorporated in the tender are approximate. However, the payments shall be made to the contractors on the basis of actual measurements taken at site.
27. The contractor shall protect the adjoining buildings or works and the work under execution from fire and shall make adequate arrangements for fire protection and firefighting and if any property is damaged, by fire due to the negligence of the contractor, the same shall be made good by the contractor at his own cost, to the entire satisfaction of Engineer-in-charge.
28. The contractor shall provide adequate lighting arrangements as approved by the Engineer-in-charge for carrying out the work during night time, if so required and also provide all other facilities for the labour employed to carry out the work as per direction of Engineer-in-Charge.
29. In order to achieve the targeted date of completion the contractor may have to work in multiple shifts, round the clock including public and gazetted holidays and nothing extra shall be paid on this account.

30. The contractor shall get the samples of all the materials to be used, in the work approved from Engineer-in-Charge and Architect before going for bulk procurement. Bulk procurement shall be taken up only after obtaining approval from the Engineer-in-charge. Any delay in getting the samples approved shall be contractor's responsibility.
31. All materials, articles and workmanship shall be of respective best quality and kind for the class described in the schedule of quantities and specifications. All materials, so used in different items of work shall be subject to the approval of the Engineer-in-charge and Architect.
32. The contractor shall be responsible for all statutory provisions and deductions towards ESI, PF or any other, as the case may be or any other levies and taxes shall be borne by the contractors. The TDS and Contract Tax or any other statutory levels/taxes incorporated from time to time shall be deducted progressively from the running account bills, as applicable at the time of payment. No claim in this regard shall be entertained.
33. The contractor is supposed to abide the minimum wages act, and shall produce all records to the Engineer-in-charge or any other statutory authority as and when called for. The Engineer-in-charge does not hold any responsibility on account of any lapses in this regard.
34. No extension of time shall be granted to the contractor on account of rains or inclement weather conditions.
 - (a) For any clarification/ doubt, the Institute may organize regular meetings with Contractor. The contractor shall attend such meetings invariably as and when required.
 - (b) In respect of the work of other agencies, where the commencement or progress of such work of any other agency is dependent upon the completion of particular portions of the contractor's work or generally upon the contractor maintaining progress in accordance with the approved coordinated construction programme, it shall be the responsibility of the Contractor to complete such portions and maintain such progress.
 - (c) Should any difference arise between the contractor and the other agencies, these shall immediately be brought to the attention of the Engineer-in-Charge who after reviewing the matters causing the differences will give their decision which shall be final and binding on the contractor.
35. All spaces allotted to the contractor as described above shall be vacated and all structures removed from site at any time as and when required and directed by the Engineer-in-charge, unconditionally and without any reservation. The Engineer-in-charge will not be obliged to give any reason for such removal. Upon receiving instructions to vacate the space, the contractor shall immediately remove all his structures, materials, etc. from the sources and clear and clean-up the site to the satisfaction of the Engineer-in-charge.
36. It shall be the responsibility of the Contractor to safeguard the site and ensure that no illegal encroachments are made by outside elements within the area allotted to the contractor. Upon completion of the work or earlier as required by Engineer-in-Charge, the contractor shall vacate the land totally without any reservation.

37. The contractor will arrange to erect, at his own cost, barbed wire or other appropriate fence around the infrastructure site, with entry/exit gates at suitable points. The contractor shall, at his own cost, provide and erect suitable fencing around the spaces allotted to him at the infrastructure sites to ensure the security of his men. Materials and equipment within the sites and in relation to other contractors who will also be allotted spaces at above sites.
38. The security of workmen, materials, equipment stores etc. within the area allotted to the contractor shall be the responsibility of the contractor.
39. The site of work shall have required equipments for various tests at site by the contractor at his own cost and nothing extra shall be payable on this account.
40. The quantities indicated are for guidance only however it may vary to any extent and the contractor should not have any financial or other implications for such variations. The owner reserves to reduce the scope of work of any item if the contractor fails to deliver the works in time and the contractor shall not ask for any financial consideration for such deletion of scope of the work.
41. The contractor shall take photographs of site prior to commencement of work, during construction and after completion of work as suggested and shall submit the photographs in soft and hard copies to IIM for which no extra payment will be made.
42. If required and directed by Engineer-In-Charge, contractor shall arrange visits of his personnel comprising of Engineer-In-Charges to various places/ plants in or out side Indore to check and verify the quality of material at manufacturer's places. No extra cost shall be given for this to contractor.
43. Deviated quantity of BOQ item or any item which is not available in the BOQ shall be paid as per DSR 2021 for Civil items & DSR 2018 for Electrical/ Electronics rates. Deviated quantity or item if is not available in BOQ & DSR (civil) 2021/ DSR(E&M) 2018 then item shall be worked out as market rate analysis. The decision of Engineer-in-charge will be conclusive and final binding on the contractor
44. Proforma of Registers to be as per standard CPWD formats.
45. Stamp Duty:
 - b. Stamp (wherever mentioned in the tender/ not mentioned but required legally), stamp duty will generally be following the Indian Stamp Act, 1899 (as applicable to Madhya Pradesh).
 - c. For the contract, the stamp duty shall be as per the Indian Stamp Act, 1899 (as applicable to Madhya Pradesh). Any revision, if made by the govt. will be applicable at the time of execution of the agreements.
 - d. The cost w.r.t. stamp duty will solely be with the bidder i.e. cost to be borne by successful bidder.
46. Inview of Covid-19, there are some entry resitrictions/ rules which you have to follow while entering into campus/ during work
 - i) All your representatives must carry the respective IDs.
 - ii) Any of your representatives should not contact any of the residents.
 - iii) The representative coming will have to undergo thermal screening at the gate.
 - iv) Any of the person with fever, cold, cough & throat pain shall not be allowed.

- v) The representatives must wear masks & gloves all the time, as without mask & gloves they will not be allowed.
- vi) The representative must carry drinking water and food, as no facility will be available here.
- vii) All your representatives to maintain social distancing.
- viii) Aarogya Setu app should be installed in the representative's mobile phones.
- ix) Spitting/chewing pan/gutka in any place on the campus is strictly prohibited.
- x) Your representative coming for entering the premises be advised to show patience as the measures will slow down the entry/exit procedure.
- xi) People coming for the referred job must be confined to their site only, as they are not allowed to move other than the designated site in the campus.
- xii) All the representatives/ workers are entering into campus should carry their vaccination certificate.

Note: No one from any containment zone will be permitted to campus.

Letter of Transmittal

To,
The Chief Engineer,
IIM Indore (M.P.)

Sub: Submission of bid for the work of “**Making, Supply & Installation of Furniture /Fixtures in Executive Residence-2 at IIM Indore.**” Vide NIT No. **IIMI/Project/07/2022/129 File No. 474**

Sir,

Having examined the details given in Notice and bid document for the above work, I/we hereby submit relevant document.

1. I/we hereby certify that all the statement made and information supplied in respect of the aforesaid bid and accompanying statements are true and correct.
2. I/we furnished all information and details necessary for eligibility and have no further pertinent information to supply.
3. I/we submit the requisite bid security declaration/ requisite certified solvency certificate and authorize the Institute i.e. IIM Indore or its officials to approach the bank issuing the same to confirm the correctness thereof. I/We also authorize IIM Indore and its officials to approach individuals, employees firms and corporation to verify our competence and general reputation.
4. I/We submit the certificates/ documents in support of our suitability, technical knowledge and capability for having successfully completed the said works (as mentioned / as attached in support of eligibility requirement)

Seal of bidder

Date of submission:

Signature(s) of Bidder(s)

Format of Bank Guarantee
Bank Guarantee for Performance Security

(On letter head of the Owner with adhesive stamp / non-judicial stamp paper of appropriate value at the time of issue of Bank Guarantee)

THIS DEED OF GUARANTEE made on _____ day of _____ 2022, between [Name of Bank], having Registered Office at [Address], (hereinafter called the “Bank” which expression shall unless repugnant to the context and meaning thereof include its successors) in favor of **Indian Institute of Management Indore having its office at Prabandh Shikhar, Rau-Pithampur Road, Indore- 453556 (M.P.)** (hereinafter called “Owner” which expression shall unless repugnant to the context and meaning thereof include its successors and assigns).

WHEREAS (IIMI) Indian Institute of Management Indore has issued a Letter of Acceptance / Letter of Intent No..... dated _____ to _____ having its Corporate office at _____ (hereinafter called the “Contractor”) which constitute a binding Contract (hereinafter called “Contract Agreement”) for carrying out the “**(Making, Supply & Installation of Furniture /Fixtures in Executive Residence-2 at IIM Indore)**” based upon the Tender submitted by the Contractor and agreed between Client and Contractor and subject to the terms therein contained. The work to be carried out by Contractor shall be supervised and implemented by M/s _____ . (hereinafter called “Contractor/Bidder”)

AND WHEREAS in accordance with the terms and conditions of the contract agreement, the Contractor has agreed to furnish a Bank Guarantee to Owner in the form of acceptable to performance guarantee for a sum of Rs. _____ (Rupees _____ Only) to ensure timely and satisfactory performance by the Contractor of its obligation under the Contract Agreement.

AND WHEREAS the Bank has at the request of the Contractor agreed to furnish this irrevocable and unconditional guarantee in favour of Owner to secure performance by the Contractor of its obligations under the Contract Agreement on the terms and conditions herein contained.

NOW THIS DEED WITHNESSTH AS FOLLOWS:

1. The Bank hereby unconditionally and irrevocably guarantees the due and punctual performance and observance of and compliance by the Contractor of the covenants, agreements, conditions and provisions expressed or implied on the part of the Contractor to be performed observed or complied with under the Contract Agreement in accordance with the terms thereof and in the event of any non-performance and non-compliance of the same for any reason, the Bank shall absolutely irrevocably and unconditionally without any demur right of set off or counter claim, forthwith upon written demand by Owner and without demur or protest and without reference to the Contractor pay to Owner a sum not exceeding Rs. _____ (Rupees _____ only). A demand so made by _____ shall be final and binding on the Bank.

2. The Bank's liability under this Guarantee is restricted to Rs. _____ (Rupees _____ only).
3. The decision of Owner for the time being in force, or at any time thereafter as to the non-performance, non-observance and non-compliance by the Contractor of the covenants, agreements, conditions and provisions, expressed or implied, on the part of the Contractor, to be observed performed or complied with under the Contract Agreement shall be final, conclusive and binding upon the Bank and shall not in any circumstances be questioned by the Bank, under what so ever circumstances.
4. Any demand for payment under this Guarantee shall be made on the Bank by Owner in writing at [Bank Address] and shall be deemed to have been sufficiently made by Owner if the writing containing the demand is sent to the Bank by registered post to the address as aforesaid or sent to the Bank by hand delivery at such address and written acknowledgement obtained to such delivery.
5. The guarantee obligations of the Bank hereunder shall continue in force and effect and be binding on the Bank in accordance with its terms upto _____ or unless extended on written demand by IIM Indore until the due performance, observance and compliance by the Contractor of all the covenants, agreements, conditions and provisions, expressed or implied, on the part of the Contractor to be observed, performed or complied with under the Contract Agreement, the completion of the Defects Liability Period and issue of the Certificate of Final Completion by Owner in accordance with the Contract Agreement.
6. As between the Bank and Owner (but without affecting the Contractors' obligations) the Bank shall be liable under this Guarantee as if it were the sole principal debtor. The Bank's liability hereunder shall not be discharged nor shall its liability be affected by:
 - a. Any time, indulgence, waiver or consent at any time given by Owner to the Contractor.
 - b. Any amendment to the Contract Agreement,
 - c. The making or the absence of any demand by Owner on the Contractor or any other person for payment.
 - d. The enforcement or absence of enforcement of the Contract Agreement or of any security or other defect in any provision of the Contract Agreement or of any of the Contractors obligations there under;
 - e. The dissolution, amalgamation, reconstruction or reorganization or appointment of any Administrative Receiver of the Contractor.
7. The Guarantee herein contained shall not be determined or in any way prejudiced or affected by any change in the constitution of the Bank/ Owner or by any merger, or amalgamation or reconstruction of the Bank / Owner but shall be enforceable against the merged, amalgamated or reconstruction body.
8. The Bank hereby expressly and irrevocably waives all claims of waiver, release, surrender or compromise and all defenses, set offs, counter claims recoupments, reductions, limitations and impairments, whatsoever.
9. Owner shall be at liberty to vary and alter or modify any of the terms and conditions of the Contract Agreement including without limitation to extend from time to time the time for the performance of the Contract Agreement by the Contractor or to postpone from time to time any of the powers exercisable by owner against the Contractor, to forbear or to enforce any of the terms and

conditions of the Contract Agreement, without in any manner affecting this Guarantee and without notice to or assent of the Bank.

10. The Bank waives any right to require/ proceeding first against the Contractor or the realization first of any other security or other guarantee, if any.
11. The Bank agrees and confirms that its obligation to make payment to Owner on demand hereunder and discharge of such obligation shall not be delayed, exercised or avoided by reason of any act or omission on the part of Owner.
12. The bank declares and confirms that the Bank has taken all necessary corporate action to authorize the execution delivery and performance of this Guarantee in accordance with the terms hereof and that the Bank has full power to enter into and perform and discharge its obligations under taken hereunder and that this Guarantee constitutes legal, valid and binding obligation of the Bank, enforceable in accordance with its terms and any defects therein or in its execution shall not be a plea for non-payment or performance of its obligation.
13. This guarantee shall be Governed by and construed in all respects according to the laws of India and shall be subject to the jurisdiction of the courts in Indore.
14. Any forbearance or indulgence on the part of Owner in the enforcement of the covenants, agreements, conditions and provisions, expressed or implied, on the part of the Contractor to be observed, performed or complied with by the Contractor under the contract agreement shall in no way relieve the Bank of its liability under the Guarantee.
15. Terms and expression defined in the contract agreement and used herein shall have the meanings assigned to them therein save and except where the context otherwise require.
16. Notwithstanding anything contained hereinabove;
 - a. Our liability under this bank guarantee shall not exceed Rs. _____ (Rupee _____)
 - b. This bank guarantee shall be valid upto _____ or and
 - c. It is a condition to our liability for payment of the guaranteed amount or part any thereof arising under this Bank guarantee that we receive a valid written claim or demand for payment under this bank guarantee on or before _____ or as provided in clause 5 failing which our liability under this bank guarantee will automatically cease.
 - d. This bank guarantee is not assignable and not transferable to third party.

IN WITNESS WHEREOF THE BANK HAS SET ITS HAND AND SEAL THE DAY AND YEAR FIRST ABOVE WRITTEN.

SIGNED for and behalf)
Of the Bank by it's duly authorized)
Representative)
In the presence of)

Q. Technical Specifications & Approved Makes

General

The specifications of the items will be guided by the respective specifications (if not truly matching then similar item) laid down in the CPWD specification in case of items relates to the DSR item & For Non-DSR items it will be guided by the item description along with the direction of Engineer-in-charge. Institute reserves the right to specify the makes in order to ensure best quality material in the interest of the work & institute.

- **Approved Make**

S.No	Material	Approved Make
1	Ply (having marine grade with fire retardant properties)	Green ply or equivalent
2	Laminate (in fire retardant category)	Marino or equivalent
3	One/Two seater sofa for BoQ item no. 23 & 24	Fetherlite / Godrej or equivalent
4	Chair	Fetherlite/ Godrej or equivalent
5	Mattress & Pilow	Sleepwell/ Kurl-on or equivalent
6	All other materials	As approved by the Engineer-in-Charge

Note: Above all the makes are suggestive, Engineer-in-Charge may select the make for approval.

SPECIFICATIONS FOR TWO SEATER SOFA (BoQ item no. 15):

1. **DIMENSIONS OF TWO SEATER SOFA:** Two Seater Sofa should have total dimension: 1755 mm (L) x 970 mm (H) x 940 mm (W), Seat Size: 1040 mm (L) x 490 mm (H) x 510 mm (W), Arm Size: 650 mm (H) x 350 mm (W), Wooden Leg Size: 90 mm (H)
2. **FRAME CONSTRUCTION, CONSTRUCTION MATERIAL LIST AND DISTRIBUTION:** Frame construction, construction material list and distribution should be as per details given below

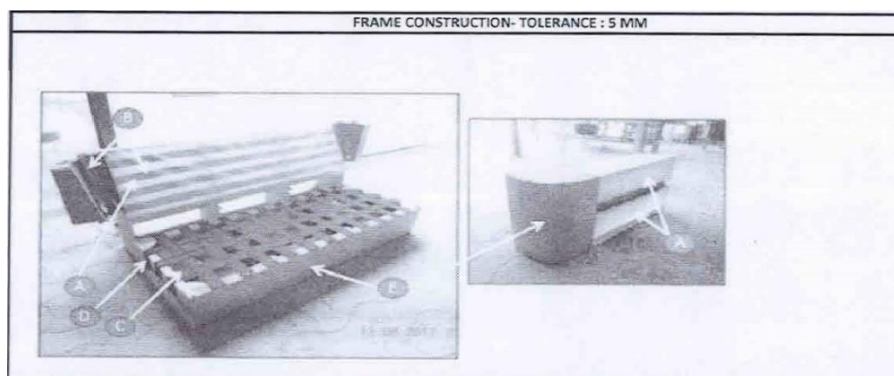

	Material Used	Dimensions	Grade
A	Non Woven	100 GSM	A
B	Webbing	48 mm	A
C	Webbing	68 mm	A
D	Cotton Belt	68 mm	A
E	MDF Sheet	2.2 mm	A

3. **FOAM DETAILS:** Foam should be as per details given below

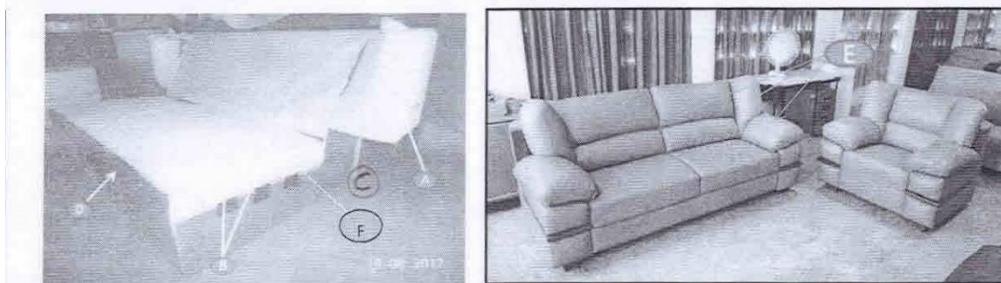

	Type	DENSITY	THICKNESS	REMARK
A	LD	28 D	10 mm	
B	Soft	28 D	45 mm	
C	Soft	28 D	45 mm	
D	Soft	28 D	22 mm	
E	Silicon Fibre (Conjugated fibre)	15 Danier 64 mm hollow silicon fibre	–	2 Seater Cushion 7.00 kg Per Arms 3+2+1' 1.00 kg
F	Wadding	N/A	175 M	

4. **UPHOLSTERY:** Upholstery should be as per details given below

	TYPE	COLOUR	WEIGHT g/m ²	THICKNESS IN MM IS:7016 (Part-1)	BREAKING STRENGTH IS:7016 (Part-2) WARP/WEFT KGF/ 5CM	TEAR STRNGT H IS:7016 (Part-3A2) WARP/WEFT IN KG	ADHESION OF COATING IS:7016 (Part-5) KGF/ 5CM	ELONGATION AT BREAKING IS:7016 (Part-2) WARP/WEFT
PVC	Artificial Leather	Orange Texas Italo	575	1.0 ± 0.10	31.42/ 18.72	4.80 KG/ 1.92 KG	2.95 KG/ 3.12 KG	52 % / 290 %

5. **HARDWARES DETAILS:** Hardwares should be as per details given below

	QTY	HARDWARES	REMARK
A		100 X 50 mm big pin	Frame assembly
B		80 X 12 mm small pin	MDF & Upolstry
C	4	M8 T-nut	Leg Fixing
D	12	BOLT M8X 65 MM	Arm & Seat Framing
E	12	M8 nut	Arm & Seat Framing
F	4	CSK Bolt M8X 40 MM	Leg Fixing
G	4	90 MM Wooden leg	Leg
H	2	Wooden Facia	Facia
I	12	SCREW M6X 32 MM	Facia Fixing

SPECIFICATIONS FOR ONE SEATER SOFA (BoQ item no. 16):

- DIMENSIONS OF ONE SEATER SOFA::** One Seater Sofa should have total dimension: 1160 mm (L) x 970 mm (H) x 940 mm (W), Seat Size: 460 mm (L) x 490 mm (H) x 510 mm (W), Arm Size: 650 mm (H) x 350 mm (W), Wooden Leg Size: 90 mm (H))
- FRAME CONSTRUCTION, CONSTRUCTION MATERIAL LIST AND DISTRIBUTION:** Frame construction, construction material list and distribution should be as per details given below.

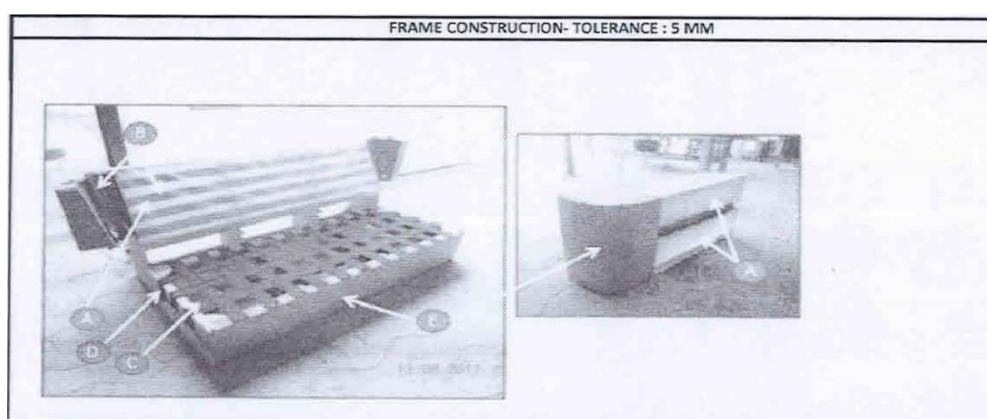

	Material Used	Dimensions	Grade
A	Non Woven	100 GSM	A
B	Webbing	48 mm	A
C	Webbing	68 mm	A
D	Cotton Belt	68 mm	A
E	MDF Sheet	2.2 mm	A

3. **FOAM DETAILS:** Foam should be as per details given below

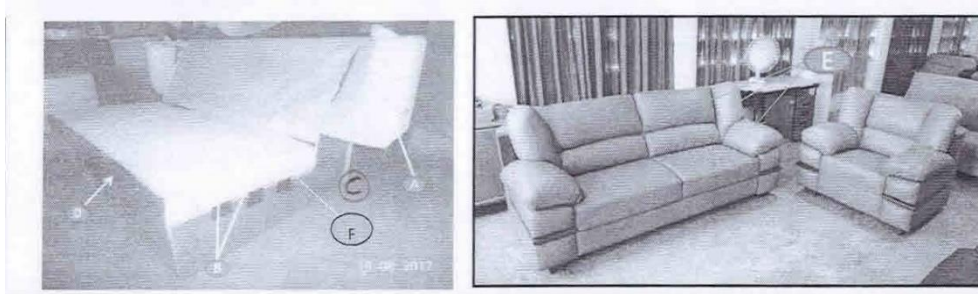

	Type	DENSITY	THICKNESS	REMARK
A	LD	28 D	10 mm	
B	Soft	28 D	45 mm	
C	Soft	28 D	45 mm	
D	Soft	28 D	22 mm	
E	Silicon Fibre (Conjugated fibre)	15 Danier 64 mm hollow silicon fibre	-	1 Seater Cushion 5.00 kg Per Arms 3+2+1' 1.00 kg
F	Wadding	N/A	176 M	

4. **UPHOLSTERY:** Upholstery should be as per details given below

	TYPE	COLOUR	WEIGHT g/m ²	THICKNESS IN MM IS:7016 (Part-1)	BREAKING STRENGTH IS:7016 (Part-2) WARP/WEFT KGF/ 5CM	TEAR STRNGT H IS:7016 (Part-3A2) WARP/WEFT IN KG	ADHESI ON OF COATIN G IS:7016 (Part-5) KGF/ 5CM	ELONGATI ON AT BREAKING IS:7016 (Part-2) WARP/ WEFT
PV C	Artificial Leather	Orange Texas Italo	575	1.0 ± 0.10	31.42/ 18.72	4.80 KG/ 1.92 KG	2.95 KG/ 3.12 KG	52 % / 290 %

5. **HARDWARES DETAILS:** Hardwares should be as per details given below

	QTY	HARDWARES	REMARK
A		100 X 50 mm big pin	Frame assembly
B		80 X 12 mm small pin	MDF & Upolstry
C	4	M8 T-nut	Leg Fixing
D	12	BOLT M8X 65 MM	Arm & Seat Framing
E	12	M8 nut	Arm & Seat Framing
F	4	CSK Bolt M8X 40 MM	Leg Fixing
G	4	90 MM Wooden leg	Leg
H	2	Wooden Facia	Facia
I	12	SCREW M6X 32 MM	Facia Fixing

Drawings:

PRODUCED BY AN AUTODESK STUDENT VERSION

WARDROBE 900X600X1980 MM

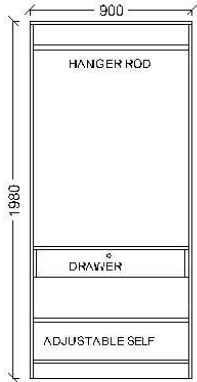

INSIDE VIEW

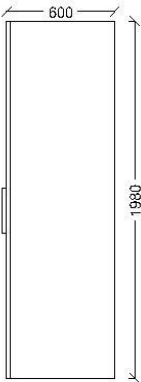

SIDE VIEW

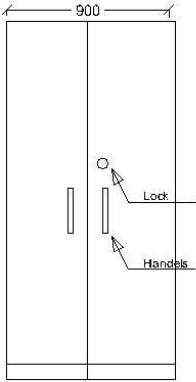

FRONT VIEW

STUDY TABLE 900X600X750 MM

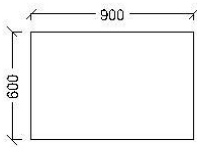

TOP VIEW

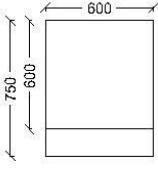

SIDE VIEW

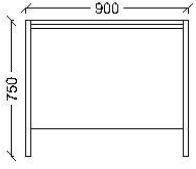

FRONT VIEW

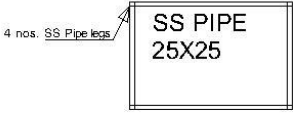

SS PIPE TOP FRAME

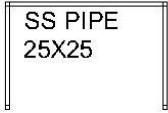

SS PIPE BOTTOM FRAME

LUGGAGE RACK 800X450X600 MM

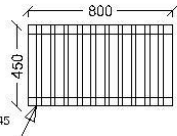

TOP VIEW

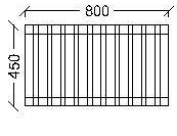

BOTTOM VIEW

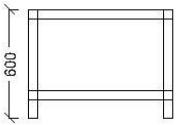

FRONT VIEW

PRODUCED BY AN AUTODESK STUDENT VERSION

PRODUCED BY AN AUTODESK STUDENT VERSION

PRODUCED BY AN AUTODESK STUDENT VERSION

PRODUCED BY AN AUTODESK EDUCATIONAL PRODUCT

CENTRE TABLE

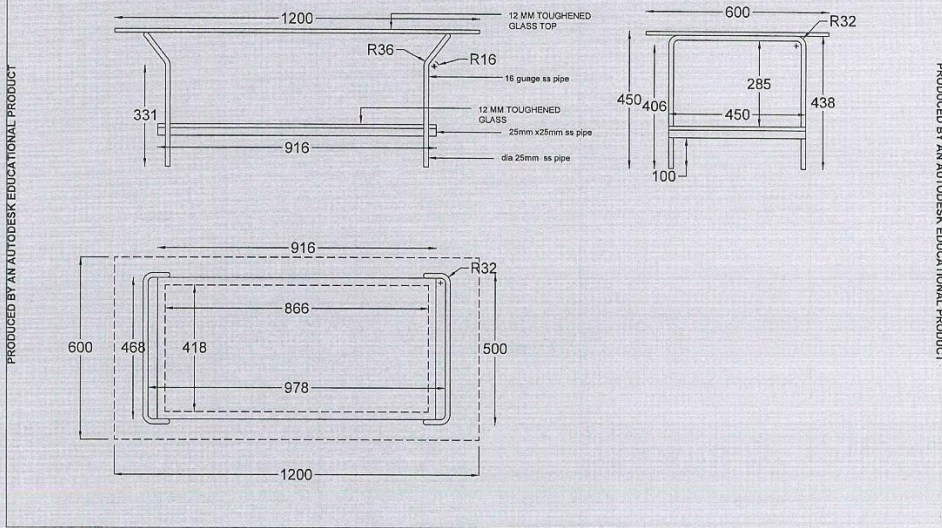

PRODUCED BY AN AUTODESK EDUCATIONAL PRODUCT

PRODUCED BY AN AUTODESK EDUCATIONAL PRODUCT

SHOE RACK 600X400X900 MM

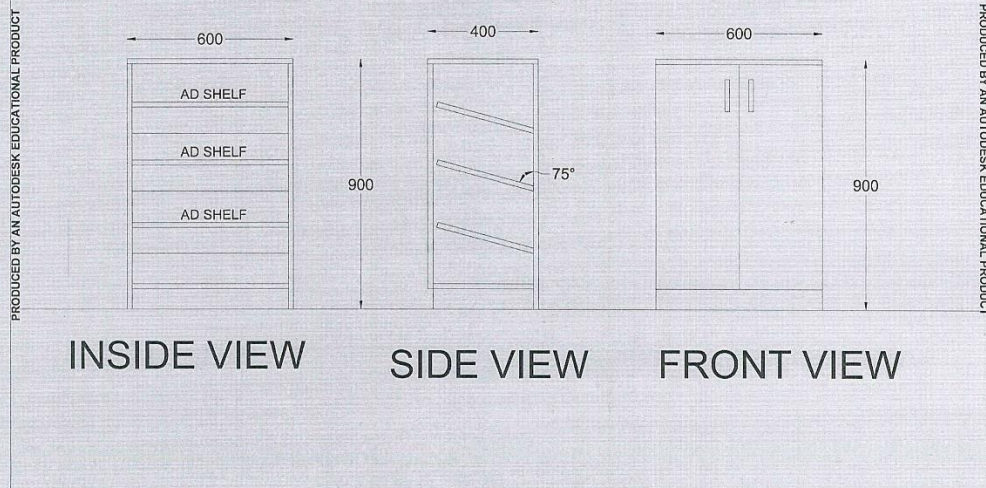

PRODUCED BY AN AUTODESK EDUCATIONAL PRODUCT

PRODUCED BY AN AUTODESK STUDENT VERSION

BED SIDE UNIT 400x400x400 MM

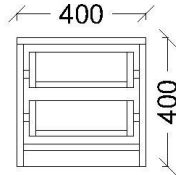

INSIDE VIEW

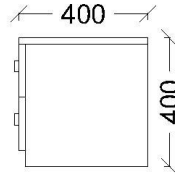

SIDE VIEW

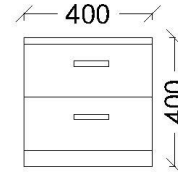

FRONT VIEW

PRODUCED BY AN AUTODESK STUDENT VERSION

TV Unit 1200X1200 MM

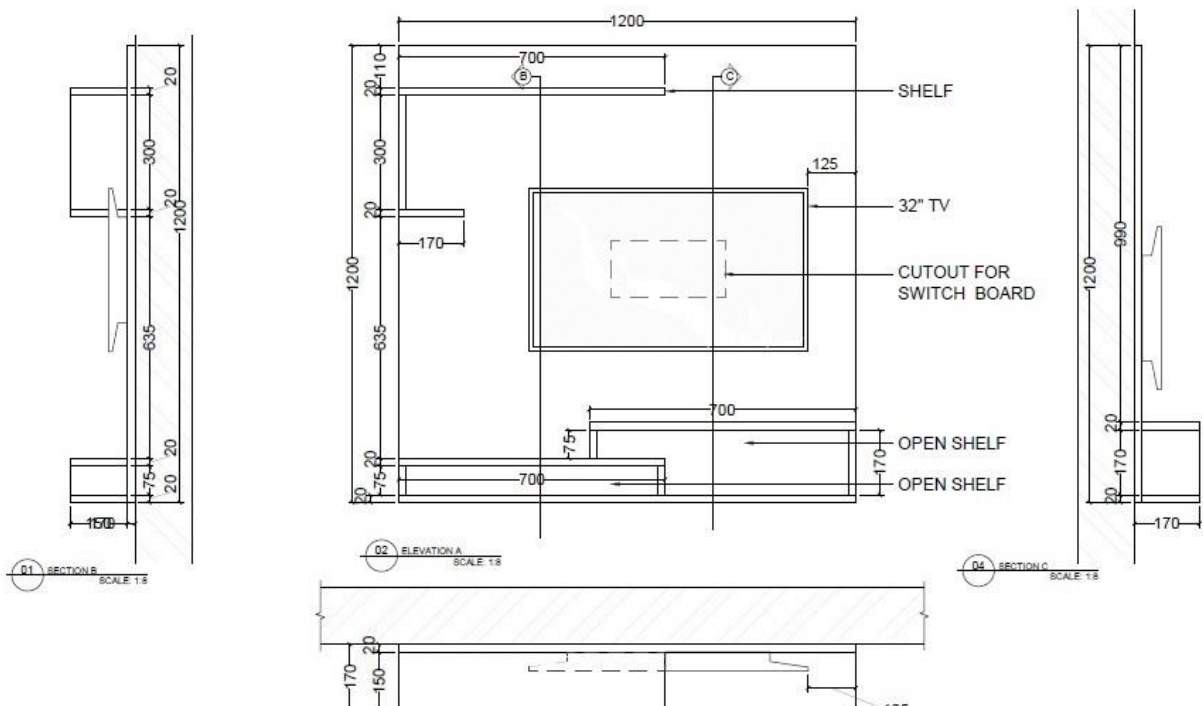

Bed unit 956X2160X900 MM

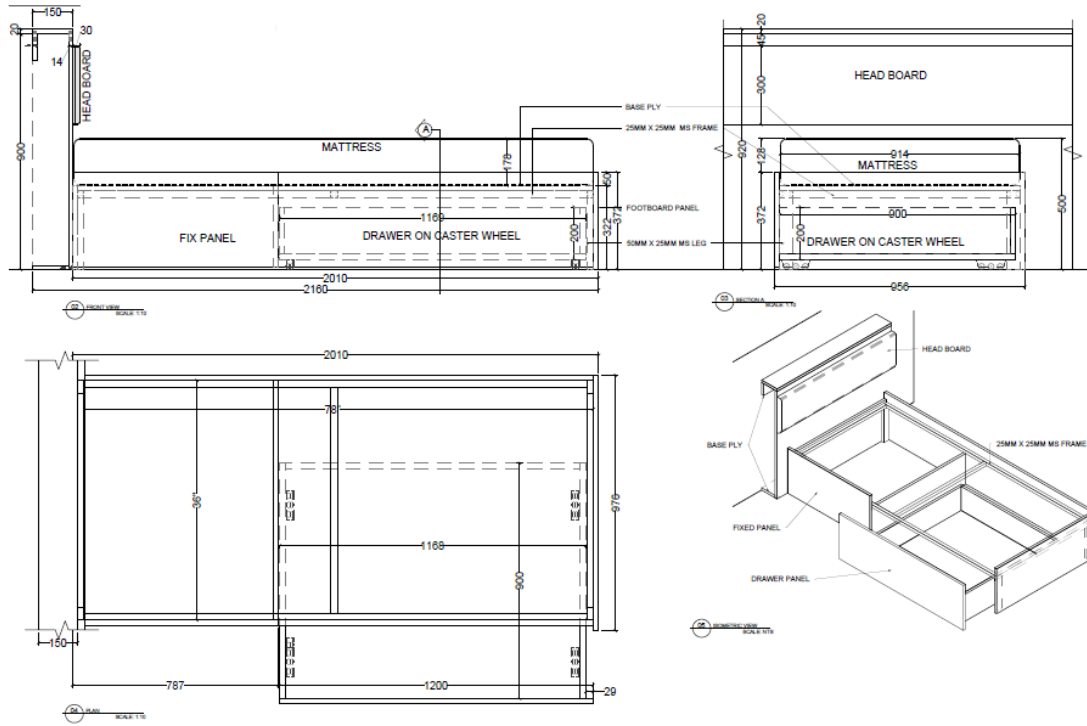



R.**FINANCIAL BID**



Financial Bid					
NIT No. IIMI/Project/07/2022/129 File No. 474					
Name of Work: "Making, Supply & Installation of Furniture /Fixtures in Executive Residence 2 at IIM Indore"					
Name of the Firm					
Address of the Firm					
Phone/Mobile no.					
E-Mail ID					
Item No	Item Description	Unit	Qty	Rate (Including GST)	Amount (Including GST)
1	Providing and fixing in position WARDROBE unit of size 900X600X1980 MM as per the approved drawing made up of 19 mm thick green defender ply or equivalent conforming to IS:5509 both side fire retardent 1.0 mm thick laminated top ,bottom, side, shelf ,vertical , skirting , drawer facia ,drawer back , drawer side etc.. with 19 mm thick both side laminated door and 9 mm thick both side laminated drawer bottom and back panel including necessary approved hinge, telescopic slide ,multipurpose lock ,hanger rod of 25mm dia 16 gauge nickel plated MS Pipe ,2nos. tower bolt of barrel type having size 150 x 10mm, 4 nos. magnetic catcher triple strip vertical type of approved quality, 250 mm handle , kd/minifix fitting, edges to be sealed with PVC edge bending tape 2.00 mm thick of approved brand fixture and finishing etc. complete job as per the direction of Engineer-in-Charge.	each	120		-

2	<p>Providing and fixing in position Bed unit of size 956X2160X900 MM along with drawer box as indicated in the drawing. All support frame of teakwood solid batten of size 45mmX45mm in periphery as well as near to the center to be placed at two levels all side(top and bottom panels) and 4 nos. vertical supports of teakwood solid batten of size 45mmX45mm as per the approved drawing. Bed head board panel , foot board , side panel , vertical panel, top & bottom panel etc. all shall be made up of 19 mm thick green defender ply or equivalent conforming to IS:5509 both side fire retardent 1.0 mm thick laminate. Bed headboard should have cushion as per approved drawing/ indicative pic. cushion may further extend upto 400mm beyond the headbord panel of the bed on one side for which no additional payment would be made. Quoted rate should also be inclusive of necessary approved hinge, castor roller suitable for this size of bed ,kd/minifix fitting, edges to be sealed with PVC edge bending tape 2.00 mm thick of approved brand fixture and finishing etc. complete job. as per approved shade and colour and as per Architecture drawing and Engineer in Charge.</p>	each	120		-
3	<p>Providing and fixing in position Bed Side unit of size 400x400x400 MM as per the approved drawing made up of 19 mm thick green defender ply or equivalent conforming to IS:5509 both side fire retardent 1.0 mm thick laminated laminated top, bottom, side, skirting, drawer facia, drawer back and 9mm thick both side laminated drawer bottom and back panel including necessary telescopic slide, 100mm handle, kd/minifix fitting, edges to be sealed with PVC edge bending tape 2.00 mm thick of approved brand fixture and finishing etc.. complete job. as per approved shade and colour and as per Architecture drawing and Engineer in Charge.</p>	each	120		-
4	<p>Providing and fixing of Head Board in rooms, made of 19 mm thick green defender ply or equivalent conforming to IS:5509 both side fire retardent 1.0 mm thick laminate including necessary screws/ fixing on wall, edges to be sealed with PVC edge bending tape 2.00 mm thick of approved brand etc. complete job as per the direction of Engineer-in-Charge.</p>	Sqm	468		-

5	Providing and fixing in position Study Table (Size in meter- L= 0.90, W= 0.60, H= 0.75) madeup of 19mm thick plywood on top & 12 mm thick plywood in 3 sides of 0.60 m height having marin grade as well as fire retardant grade of green ply defender or equivalent, duly laminated both side with fire retardant laminate of 1mm thick. Structure would be of stainless steel 304 Square Pipe 25X25 & 2 mm thick, design of structure would be as per the instructions of Engineer-in-Charge. The quoted rates should include all inclusive of supplying of material, making, installing at site, necessary screws, finishing etc. all complete job.	each	120		-
6	Providing and fixing in position luggage Rack (Size in meter- L= 0.80, W= 0.45, H= 0.60) madeup of second class teakwood , all four sides top & bottom frame madeup of 45mmX45mm battens, 4 nos. post of 45mmX45mm, 9 nos. wooden battens of size 22.5mmX45mm in top with s.s metal strip & bottom each. design of structure would be as per the instructions of Engineer-in-Charge. The quoted rates should include all inclusive of supplying of material, making, installing at site, necessary screws, PU finish polishing, finishing etc. all complete job.	each	120		-
7	Providing and fixing mirror of superior glass (of approved quality) and of required shape and size with plastic moulded frame of approved make and shade with 6 mm thick hard board backing : Rectangular shape 1500x450 mm	each	60		-
8	Supply & Installation of Midback mesh chair of featherlite make (model - optima) or equivalent. having Upholstery: Cushion with pre moulded foam of 50 - 60 density in the shape of plywood of Density -- 52 kg/m ³ , Hardness -- 12.6kgf at 25%, back having adjustable lumber support, Moulded polyurethane Arms conforming to IS 7078 with steel inserts for long life. 2 way adjustable - Height Adjustable & Swivel, Chrome Base: Specially designed 5 pronged structure forged out of CR Sheets of 2 mm thick. Base of diameter 26 inches for complete stability, extreme durability, sturdiness and pleasant aesthetic looks. Reinforced with CO ₂ welding to provide additional strength and support.	each	150		-



	<p>Dimensions of Chair Seat: Depth- 510 mm Width- 620mm Minimum seat height- 575mm Maximum seat height- 620mm width (arm to arm)- 620mm arm rest height- 185-265mm</p>				
					
9	<p>Supply & installation of spine tech air luxury model of sleepwell or equivalent mattress of size 78x36x7 inches of triple layer support system, High Resilience Layer for Comfort, Premium Knitted Fabric, Rebounded Layer for Support, Impression Memory Foam in Top Quilting, etc including two luxury pillows of minimum MRP of Rs.2500/- of sleepwell or equivalent with each mattress.</p>	each	120		-
10	<p>Supply & installation of portable wooden & Cushion Stool for dressing made up of 19 mm thick green defender ply or equivalent conforming to IS:5509 both side fire retardent 1.0 mm thick laminated laminated having width x Height: 12 inch x 18 inch (Excl. cushion height) & cushion thickness minimum 4 inches with pre moulded foam of 50 - 60 density in the shape of plywood of Density -- 52 kg/m3 etc. all complete as per the direction of Engineer-in-Charge. (Indicative photo given below for better understanding of actual requirement)</p>	each	60		-
					



11	<p>Providing & Fixing up of Window curtain (Roller blind model) Black out type in required sizes having the following specification: Control unit: The Control unit should be made of high strength reinforced plastic. The clutch is of wrap spring design. High carbon steel springs are provided to transmit motion from driving to driven members of clutch mechanism. Clutch is operated directionally by the use of endless beaded chain. Clutch never needs any adjustment. Idler: Idler is of high strength reinforced plastic, consisting of a Centre shaft. The idler is mounted on the bracket by using a plastic lock. The metal sleeve inside the plastic lock provides bearing surface for the Centre shaft, which rotates freely, providing smooth, quiet and long wearing operation. Head rail: It is an aluminum extruded rail Powder coated in white. Control unit and Idler are mounted on the Head rail with powder coated M.S. brackets. Roller tube: It is an anodized extruded tube of high strength alloy. Control unit and Idler are fixed to the either ends of the tube. The fabric of the blind is fitted to the tube with heavy duty adhesive tape etc. complete as per direction of Engineer-in-Charge.</p>	Sqm	180		-
12	<p>Providing and fixing in position TV Unit of size 1200X1200 MM as per the approved drawing made up of 19 mm thick green defender ply or equivalent conforming to IS:5509 both side fire retardant 1.0 mm thick laminate, edges to be sealed with PVC edge bending tape 2.00 mm thick of approved brand fixture and finishing etc. complete job as per the direction of Engineer-in-Charge.</p>	each	60		-
13	<p>Providing and fixing in position of Round Cafe Table Dia 900 mm X H 750 mm. ISOTOP Table top thickness 20 mm edge profile from 18mm to 35 mm melamine laminated surface with post form edges . SS 304 grade metal legs with footrest. The table top should be damp proof, heat resistant , Scratch resistant. Resistance to heat – 30 mins @ 100 Degree C Density- 750-800 kg/m cube Withstand weight upto 3200 grams.</p>	each	60		-
					
14	<p>Supply and Installation of Victorian style wooden chair for Coffee Table made up of sheesham wood with PU finish & required thickness of premium leatherette upholstered with cushion minimum 2-3 inches and legs should be of cabriole styled as indicated in the below picture of required design of</p>	each	120		-



	size 42"X16"X20" (HxWxD) etc. all complete of approve design/ quality & as per direction of Engineer-in-Charge.				
					
15	Supply and Installation of two seater sofa of Godrej Interio Make (Model- Conforto) or equivalent should have total dimension: 1755 mm (L) x 970 mm (H) x 940 mm (W), Seat Size: 1040 mm (L) x 490 mm (H) x 510 mm (W), Arm Size: 650 mm (H) x 350 mm (W), Wooden Leg Size: 90 mm (H), Primary Material made of pine wood, Upholstery Material of Leatherette, Seat Height would be of 47cm etc. all complete as per the specifications given in tender and direction of Engineer-in-Charge. (Indicative photo of sofa given below for better understanding of actual requirement)	each	10		-
					
16	Supply and Installation of one seater sofa of Godrej Interio Make (Model- Conforto) or equivalent should have total dimension: 1160 mm (L) x 970 mm (H) x 940 mm (W), Seat Size: 460 mm (L) x 490 mm (H) x 510 mm (W), Arm Size: 650 mm (H) x 350 mm (W), Wooden Leg Size: 90 mm (H) , Primary Material made of pine wood, Upholstery Material of Leatherette, Seat Height would be of 47cm etc. all complete as per the specifications given in tender and direction of Engineer-in-Charge. (Indicative photo of sofa given below for better understanding of actual requirement)	each	6		-
					

17	<p>Providing and fixing in position Centre Table unit of size 1200X600X450 MM as per the approved drawing made up of Stainless Steel 304 grade 16 gauge pipe frame, toughened glass 12mm thick Top Size 1200 x 600 MM and bottom Size 916 x 468 MM , Chrome finish, materials conforming to relevant IS Standard including necessary fittings of approved brand fixture and finishing etc. complete job as per approved shade and colour and as per Architecture drawing and Engineer in Charge.</p>	each	6		-
18	<p>Providing and fixing aluminium work for doors, windows, ventilators and partitions with extruded built up standard tubular sections/ appropriate Z sections and other sections of approved make conforming to IS: 733 and IS: 1285, fixing with dash fasteners of required dia and size, including necessary filling up the gaps at junctions, i.e. at top, bottom and sides with required EPDM rubber/ neoprene gasket etc. Aluminium sections shall be smooth, rust free, straight, mitred and jointed mechanically wherever required including cleat angle, Aluminium snap beading for glazing / paneling, C.P. brass / stainless steel screws, all complete as per architectural drawings and the directions of Engineer-in-charge. (Glazing, paneling and dash fasteners to be paid for separately) : For fixed portion. Anodised aluminium (anodised transparent or dyed to required shade according to IS: 1868, Minimum anodic coating of grade AC 15)</p>	kg	350		-

19	Providing and fixing aluminium work for doors, windows, ventilators and partitions with extruded built up standard tubular sections/ appropriate Z sections and other sections of approved make conforming to IS: 733 and IS: 1285, fixing with dash fasteners of required dia and size, including necessary filling up the gaps at junctions, i.e. at top, bottom and sides with required EPDM rubber/ neoprene gasket etc. Aluminium sections shall be smooth, rust free, straight, mitred and jointed mechanically wherever required including cleat angle, Aluminium snap beading for glazing / paneling, C.P. brass / stainless steel screws, all complete as per architectural drawings and the directions of Engineer-in-charge. (Glazing, paneling and dash fasteners to be paid for separately) : For shutters of doors, windows & ventilators including providing and fixing hinges/ pivots and making provision for fixing of fittings wherever required including the cost of EPDM rubber / neoprene gasket required (Fittings shall be paid for separately). Anodised aluminium (anodised transparent or dyed to required shade according to IS: 1868, Minimum anodic coating of grade AC 15)	kg	50		-
20	Providing and fixing glazing in aluminium door, window, ventilator shutters and partitions etc. with EPDM rubber / neoprene gasket etc. complete as per the architectural drawings and the directions of engineer-in-charge . (Cost of aluminium snap beading shall be paid in basic item): With float glass panes of 5 mm thickness (weight not less than 12.50 kg/sqm)	sqmt	72		-
21	Providing & Pasting Frosted Film of thickness 100 micron in required design all complete job as per the direction of Engineer-in-charge.	sqm	72		-
22	Providing and fixing Brass 100mm mortice latch and lock with 6 levers without pair of handles (best make of approved quality) for aluminium doors including necessary cutting and making good etc. complete	Sqm	4		-
23	Providing and fixing in position SHOE RACK unit of size 600X400X900 MM as per the approved drawing made up of 19 mm thick green defender ply or equivalent conforming to IS:5509 both side fire retardant 1.0 mm thick laminated top ,bottom, side ,skirting ,door and 9 mm thick both side laminated back panel including necessary approved hinge , 150 mm handle , kd/minifix fitting, edges to be sealed with PVC edge bending tape 2.00 mm thick of approved brand fixture and finishing etc. complete job as per the direction of Engineer-in-Charge.	each	60		-

24	Design, drawing, specification, finishing details, rate analysis, 3-D modelling, architectural view, structural view, pattern & colour detailing etc. by a professional architect/ interior designer etc. all complete as per the direction of Engineer-in-Charge.	LS	1		-
25	Providing & laying of Corion solid surface sheet of 19mm thick for tables/ counters/ reception desk/ island etc. of required colour/ texture/ design/ shape in horizontal/ vertical position of premium quality etc. Rate should include supply, fabrication, finishing required adhesion, moulding & application etc. all complete.	Sqft	50		-
Buy Back Items					
26	Buy Back Offer: Single Bed only of approx. size 900x900x1980 mm (WxHxL) as per the direction of Engineer-in-Charge under Buy Back Offer. Bidder may visit the actual site to understand the actual condition/ material of the said item before quoting buy back rates & it will be as is where is basis. rate should include dismantling/ carriage/ any other charges required for taking out the item out of the campus. (Indicative pic is given below)	each	-120		-
					
27	Buy Back Offer: Wardrobe of approx. size 900x1980x600 mm (WxHxD) with all associated accessories as per the direction of Engineer-in-Charge under Buy Back Offer. Bidder may visit the actual site to understand the actual condition/ material of the said item before quoting buy back rates & it will be as is where is basis. rate should include dismantling/ carriage/ any other charges required for taking out the item out of the campus. (Indicative pic is given below)	each	-120		-
					

28	Buy Back Offer: Study Table of approx. size 900x750x600 mm (WxHxD) with all associated accessories as per the direction of Engineer-in-Charge under Buy Back Offer. Bidder may visit the actual site to understand the actual condition/ material of the said item before quoting buy back rates & it will be as is where is basis. rate should include dismantling/ carriage/ any other charges required for taking out the item out of the campus. (Indicative pic is given below)	each	-120		-
					
29	Buy Back Offer: Mid back revolving chair of approx. size 550x650 mm (WxD) with all associated accessories as per the direction of Engineer-in-Charge under Buy Back Offer. Bidder may visit the actual site to understand the actual condition/ material of the said item before quoting buy back rates & it will be as is where is basis. rate should include dismantling/ carriage/ any other charges required for taking out the item out of the campus. (Indicative pic is given below)	each	-120		-
					
30	Buy Back Offer: Circular Coffee table of approx. Dia. 750mm & height 750m with all associated accessories as per the direction of Engineer-in-Charge under Buy Back Offer. Bidder may visit the actual site to understand the actual condition/ material of the said item before quoting buy back rates & it will be as is where is basis. rate should include dismantling/ carriage/ any other charges required for taking out the item out of the campus. (Indicative pic is given below)	each	-60		-
					

31	Buy Back Offer:Mid back Coffee chair of approx. size 410x450 mm (WxD) with all associated accessories as per the direction of Engineer-in-Charge under Buy Back Offer. Bidder may visit the actual site to understand the actual condition/ material of the said item before quoting buy back rates & it will be as is where is basis. rate should include dismanteling/ carrige/ any other charges required for taking out the item out of the campus. (Indicative pic is given below)	each	-120		-
					
32	Buy Back Offer: Bed side unit of approx. size400x400x400 mm (WxHxD) with all associated accessories as per the direction of Engineer-in-Charge under Buy Back Offer. Bidder may visit the actual site to understand the actual condition/ material of the said item before quoting buy back rates & it will be as is where is basis. rate should include dismanteling/ carrige/ any other charges required for taking out the item out of the campus. (Indicative pic is given below)	each	-120		-
					
Total Amount in Rs. (Including GST)					0

Note:

1. The Financial Bid is to be filled through e-procurement portal namely e-Wizard through <https://mhrd.euniwizarde.com>
2. Any other mode of bid submission will not be accepted.

Tender Inviting Authority